

*Tender Fee: Rs. 5,000/-
(Non-Refundable)*

TENDER FORM

Tender # CW/01/24-25

Construction of Main Gate No. 1 at IBA Main Campus

Date of Issue : July 10, 2024

Last Date of Submission : July 24, 2024 (3:00 pm)

Date of Opening : July 24, 2024 (3:30 pm)

Company Name: _____

NTN: _____

SRB / GST Registration Number: _____

Pay Order / Demand Draft # _____, **Drawn on Bank** _____

Amount of Rs. _____, **Dated:** _____

SUMMARY OF CONTENTS

<u>Subject</u>	<u>Page No</u>
(I) INVITATION FOR BIDS.....	02
(II) INSTRUCTIONS TO BIDDERS & BIDDING DATA.....	05
(III) FORM OF BID & SCHEDULES TO BID.....	20
(IV) CONDITIONS OF CONTRACT & CONTRACT DATA.....	33
(V) STANDARD FORMS.....	54
(VI) SPECIFICATIONS.....	67
(VII) DRAWINGS.....	79

INVITATION FOR BIDS

Notice Invitation Tender (NIT)**Tender Notice**

The Institute of Business Administration, Karachi (IBA) invites sealed bids from active taxpayers of civil work contractors registered with relevant tax authorities for the following tender.

Tender Title (Ref. No.)	Procedure	Bid Security
Construction of Main Gate No. 1 at IBA Main Campus (CW/01/24-25)	Single Stage One Envelope	2% of bid security
<ul style="list-style-type: none"> • Fee: Rs.5,000/- each • Issuance start date: July 10, 2024 at 9 AM • Issuance end date & time: July 24, 2024 at 3 PM • Submission date & time: July 10, 2024 to July 24, 2024 from 9 AM to 3 PM • Opening date & time: July 24, 2024 at 3:30 PM • Mandatory Site Visit: July 19, 2024 at 11 AM at IBA Main Campus 		

Tender Document may be collected after submission of paid fee challan from the Office of **Head of Procurement, Fauji Foundation Building, IBA Main Campus, University Enclave, Karachi** on any working day (Monday to Friday). Alternatively, the tender document can be downloaded from the website. The Tender fee challan is to be generated from the IBA website <https://www.iba.edu.pk/tenders/> which may be deposited in any branch of Meezan Bank Ltd. Sealed bids should be dropped in Tender Box placed at the Security Office, Gate # 4, IBA Main Campus University Enclave Karachi and will be opened on same date & venue in the presence of the bidders representatives who may wish to attend. In case of holiday the tender shall be opened / received on the next working day at same place and time. Bid Security in the form of Pay Order or Demand Draft has to be submitted in favour of “**IBA Karachi**” along with the Financial Proposal.

Kindly mention “Tender Number” at top left corner of the envelope.

N.B. IBA Karachi reserves the right to reject any bid or cancel the bidding process subject to relevant provision of SPP Rules 2010.

REGISTRAR

IBA, Main Campus, Univeristy Enclave, Karachi 75270
111-422-422 Fax (92-21) 99261508
Contact Person Sr. Executive Purchase on 38104700 ext: 2150

Email tenders@iba.edu.pk

Website <https://www.iba.edu.pk/tenders/>

<https://ppms.pprasinhd.gov.pk/PPMS/public/portal/notice-inviting-tender>

**INSTRUCTIONS
TO BIDDERS
&
BIDDING DATA**

Notes on the Instructions to Bidders

This section of the bidding documents should provide the information necessary for bidders to prepare responsive bids, in accordance with the requirements of the Procuring Agency. It should also give information on bid submission, opening and evaluation, and on the award of contract.

Matters governing the performance of the Contract or payments under the Contract, or matters affecting the risks, rights, and obligations of the parties under the Contract are not normally included in this Section, but rather in the appropriate sections of the *Conditions of Contract* and/or *Contract Data*.

TABLE OF CONTENTS

INSTRUCTIONS TO BIDDERS

<i>Clause No.</i>	<i>Description</i>	<i>Page No.</i>
A. GENERAL		
IB.1	Scope of Bid & Source of Funds.....	6
IB.2	Eligible Bidders.....	6
IB.3	Cost of Bidding.....	7
B. BIDDING DOCUMENTS		
IB.4	Contents of Bidding Documents.....	7
IB.5	Clarification of Bidding Documents.....	7
IB.6	Amendment of Bidding Documents.....	8
C- PREPARATION OF BID		
IB.7	Language of Bid.....	8
IB.8	Documents Comprising the Bid.....	8
IB.9	Sufficiency of Bid.....	8
IB.10	Bid Prices, Currency of Bid & Payment.....	9
IB.11	Documents Establishing Bidder’s Eligibility and Qualifications...	9
IB.12	Documents Establishing Works Conformity to Bidding Documents.....	9
IB.13	Bidding Security.....	10
IB.14	Validity of Bids, Format, Signing and Submission of Bid.....	10
D-SUBMISSION OF BID		
IB.15	Deadline for Submission, Modification & Withdrawal of Bids....	11
E. BID OPENING AND EVALUATION		
IB.16	Bid Opening, Clarification and Evaluation.....	12
IB.17	Process to be Confidential.....	13
F. AWARD OF CONTRACT		
IB.18	Qualification.....	13
IB.19	Award Criteria & Procuring Agency’s Right.....	14
IB.20	Notification of Award & Signing of Contract Agreement.....	14
IB.21	Performance Security.....	14
IB.22	Integrity Pact.....	15

INSTRUCTIONS TO BIDDERS

(Note: *These Instructions to Bidders (IB) along with Bidding Data will not be part of Contract and will cease to have effect once the Contract is signed*).

A. GENERAL

IB.1 Scope of Bid & Source of Funds

1.1 Scope of Bid

The Procuring Agency as defined in the Bidding Data (hereinafter called —the Procuring Agency||) wishes to receive Bids for the Works summarized in the Bidding Data (hereinafter referred to as —the Works).

Bidders must quote for the complete scope of work. Any Bid covering partial scope of work will be rejected as non-responsive. Site visit will be held on July 19, 2024 at IBA Main Campus at 11am with Sr. Manager Contracts (Project) for understanding the exact nature of the job.

1.2 Source of Funds

The Procuring Agency has arranged funds from its own sources or *Federal/ Provincial /Donor agency or any other source*, which may be indicated accordingly in bidding data towards the cost of the project/scheme.

IB.2 Eligible Bidders

2.1 Bidding is open to all firms and persons meeting the following requirements:

- a) Duly licensed by the Pakistan Engineering Council (PEC) in the Cat C-6 or above.

In the event that prequalification of potential bidders has been undertaken, only bids from prequalified bidders will be considered for award of Contract.

- b) if prequalification has not undertaken, the procuring agency may ask information and documents not limited to following:-
 - (i) company profile;
 - (ii) works of similar nature Minimum 3 Nos performed in last 5 years. Documentary evidence in the form of work order /agreement or experience certificate is mandatory.

- (iii) construction equipment . Scaffolding Pipes & Joints.
- (iv) qualification and experience of technical personnel and key site management.
- (v) Bank financial statement of last 3 years.
- (vi) information regarding litigations and abandoned works if any.

IB.3 Cost of Bidding

3.1 The bidder shall bear all costs associated with the preparation and submission of its bid and the Procuring Agency will in no case be responsible or liable for those costs, regardless of the conduct or outcome of the bidding process (SPP Rules 24 & 25).

B. BIDDING DOCUMENTS

IB.4 Contents of Bidding Documents

4.1 In addition to Invitation for Bids, the Bidding Documents are those stated below, and should be read in conjunction with any Addendum issued in accordance with Sub-Clause IB.6.1.

1. Instructions to Bidders & Bidding Data
2. Form of Bid, Qualification Information & Schedules to Bid Schedules to Bid comprise the following:
 - (i) Schedule A: Schedule of Prices/ Bill of Quantities (BoQ).
 - (ii) Schedule B: Specific Works Data
 - (iii) Schedule C: Works to be Performed by Subcontractors.
 - (iv) Schedule D: Proposed Programme of Works
 - (v) Schedule E: Method of Performing Works
 - (vi) Schedule F: Integrity Pact (works costing Rs 10 million and above)
3. Conditions of Contract & Contract Data
4. Standard Forms:
 - (i) Form of Bid Security,
 - (ii) Form of Performance Security;
 - (iii) Form of Contract Agreement.
 - (iv) Form of Bank Guarantee for Advance Payment.
5. Specifications
6. Drawings, if any

IB.5 Clarification of Bidding Documents

5.1 A prospective bidder requiring any clarification(s) in respect of the Bidding Documents may notify the Engineer/Procuring Agency at the Engineer's/ Procuring Agency's address indicated in the Bidding Data.

5.2 An interested bidder, who has obtained bidding documents, may request for clarification of contents of bidding documents in writing and procuring agency shall respond to such queries in writing within three calendar days, provided they are received at least five calendar days prior to the date of opening of bid (SPP Rule 23-1).

IB.6 Amendment of Bidding Documents (SPP Rules 22(2) & 22).

6.1 At any time prior to the deadline for submission of Bids, the Procuring Agency may, for any reason, whether at his own initiative or in response to a clarification requested by a interested bidder, modify the Bidding Documents by issuing addendum.

6.2 Any addendum thus issued shall be part of the Bidding Documents pursuant to Sub Clause

6.1 hereof and shall be communicated in writing to all purchasers of the Bidding Documents. Prospective bidders shall acknowledge receipt of each addendum in writing to the Procuring Agency.

6.3 To afford interested bidders reasonable time in which to take an addendum into account in preparing their Bids, the Procuring Agency may at its discretion extend the deadline for submission of Bids.

C. PREPARATION OF BIDS

IB.7 Language of Bid

7.1 All documents relating to the Bid shall be in the language specified in the Contract Data.

IB.8 Documents Comprising the Bid

8.1 The Bid submitted by the bidder shall comprise the following:

- (a) Offer /Covering Letter
- (b) Form of Bid duly filled, signed and sealed, in accordance with IB.14.3.
- (c) Schedules (A to F) to Bid duly filled and initialed, in accordance with the instructions contained therein & in accordance with IB.14.3.
- (d) Bid Security furnished in accordance with IB.13.
- (e) Power of Attorney in accordance with IB 14.5.
- (f) Documentary evidence in accordance with IB.2(c) & IB.11
- (g) Documentary evidence in accordance with IB.12.

IB.9 Sufficiency of Bid

9.1 Each bidder shall satisfy himself before Bidding as to the correctness and sufficiency of his Bid and of the premium on the rates of CSR / rates and prices quoted/entered in the Schedule of Prices, which rates and prices shall except in so far as it is otherwise expressly provided in the Contract, cover all his obligations under the Contract and all matters and things necessary for the proper completion of the works.

9.2 The bidder is advised to obtain for himself at his own cost and responsibility all information that may be necessary for preparing the bid and entering into a Contract for execution of the Works.

IB.10 Bid Prices, Currency of Bid and Payment

10.1 The bidder shall fill up the Schedule of Prices (Schedule A to Bid) indicating the percentage above or below the Composite Schedule of Rates/unit rates and prices of the Works to be performed under the Contract. Prices in the Schedule of Prices/Bill of Quantities shall be quoted entirely in Pak Rupees keeping in view the instructions contained in the Preamble to Schedule of Prices.

10.2 Unless otherwise stipulated in the Conditions of Contract, prices quoted by the bidder shall remain fixed during the bidder's performance of the Contract and not subject to variation on any account.

10.3. The unit rates and prices in the Schedule of Prices or percentage above or below on the composite schedule of rates shall be quoted by the bidder in the currency as stipulated in Bidding Data.

10.4 Items for which no rate or price is entered by the Bidder will not be paid for by the Procuring Agency when executed and shall be deemed covered by the other rates and prices in the Bill of Quantities.

IB.11 Documents Establishing Bidder's Eligibility and Qualifications

11.1 Pursuant to Clause IB.8, the bidder shall furnish, as part of its bid, documents establishing the bidder's eligibility to bid and its qualifications to perform the Contract if its bid is accepted.

11.2 Bidder must possess and provide evidence of its capability and the experience as stipulated in Bidding Data and the Qualification Criteria mentioned in the Bidding Documents.

IB.12 Documents Establishing Works' Conformity to Bidding Documents

12.1 The documentary evidence of the Works 'conformity to the Bidding Documents may be in the form of literature, drawings and data and the bidder shall furnish documentation as set out in Bidding Data.

12.2 The bidder shall note that standards for workmanship, material and equipment, and references to brand names or catalogue numbers, *if any*, designated by the Procuring Agency in the Technical Provisions are intended to be descriptive only and not restrictive.

IB.13 Bid Security

13.1 Each bidder shall furnish, as part of his bid, at the option of the bidder, a Bid Security as percentage of bid price/estimated cost or in the amount stipulated in Bidding Data in Pak. Rupees in the form of *Deposit at Call/ Payee's Order or a Bank Guarantee* issued by a Scheduled Bank in Pakistan in favor of the Procuring Agency valid for a period up to twenty eight (28) days beyond the bid validity date (*Bid security should not be below 2%.and not exceeding 5% of bid price/estimated cost SPP Rule 37*).

13.2 Any bid not accompanied by an acceptable Bid Security shall be rejected by the Procuring Agency as non-responsive.

13.3 The bid securities of unsuccessful bidders will be returned upon award of contract to the successful bidder or on the expiry of validity of Bid Security whichever is earlier.

13.4 The Bid Security of the successful bidder will be returned when the bidder has furnished the required Performance Security, and signed the Contract Agreement (SPP Rule 37).

13.5 The Bid Security may be forfeited:

- (a) if a bidder withdraws his bid during the period of bid validity; or
- (b) if a bidder does not accept the correction of his Bid Price, pursuant to Sub-Clause 16.4 (b) hereof; or
- (c) in the case of a successful bidder, if he fails within the specified time limit to:

(i) furnish the required Performance Security or (ii) sign the contract Agreement.

IB.14 Validity of Bids, Format, Signing and Submission of Bid

14.1 Bids shall remain valid for the period stipulated in the Bidding Data after the date of bid opening.

14.2 In exceptional circumstances, Procuring Agency may request the bidders to extend the period of validity for a additional period but not exceeding 1/3 of the original period. The request and the bidders' responses shall be made in writing or by cable. A Bidder may refuse the request without forfeiting the Bid Security. A Bidder agreeing to the request will not be required or permitted to otherwise modify the Bid but will be required to extend the validity of Bid Security for the period of the extension, and in compliance with IB.13 in all respects (SPP Rule 38).

14.3 All Schedules to Bid are to be properly completed and signed.

14.4 No alteration is to be made in the Form of Bid except in filling up the blanks as directed. If any alteration be made or if these instructions be not fully complied with, the bid may be rejected.

14.5 Each bidder shall prepare Original and number of copies specified in the Bidding Data of the documents comprising the bid as described in IB.8 and clearly mark them —ORIGINAL|| and —COPY|| as appropriate. In the event of discrepancy between them, the original shall prevail.

14.6 The original and all copies of the bid shall be typed or written in indelible ink and shall be signed by a person or persons duly authorized to sign (in the case of copies, Photostats are also acceptable). This shall be indicated by submitting a written Power of Attorney authorizing the signatory of the bidder to act for and on behalf of the bidder. All pages of the bid shall be initialed and official seal be affixed by the person or persons signing the bid.

14.7 The Bid shall be delivered in person or sent by registered mail at the address to Procuring Agency as given in Bidding Data.

D. SUBMISSION OF BID

IB.15 Deadline for Submission, Modification & Withdrawal of Bids

15.1 Bids must be received by the Procuring Agency at the address/provided in Bidding Data not later than the time and date stipulated therein.

15.2 The inner and outer envelopes shall

- (a) be addressed to the Procuring Agency at the address provided in the Bidding Data;
- (b) bear the name and identification number of the Contract as defined in the Bidding and Contract Data; and
- (c) provide a warning not to open before the specified time and date for Bid opening as defined in the Bidding Data.
- (d) in addition to the identification required in 15.2, the inner envelopes shall indicate the name and address of the Bidder to enable the Bid to be returned unopened in case it is declared late.
- (e) If the outer envelope is not sealed and marked as above, the Procuring Agency will assume no responsibility for the misplacement or premature opening of the Bid.

15.3 Bids submitted through telegraph, telex, fax or e-mail shall not be considered.

15.4 Any bid received by the Procuring Agency after the deadline for submission prescribed in Bidding Data will be returned unopened to such bidder.

- 15.5 Any bidder may modify or withdraw his bid after bid submission provided that the modification or written notice of withdrawal is received by the Procuring Agency prior to the deadline for submission of bids.
- 15.6 Withdrawal of a bid during the interval between the deadline for submission of bids and the expiration of the period of bid validity specified in the Form of Bid may result in forfeiture of the Bid Security pursuant to IB.13.5 (a).

E. BID OPENING AND EVALUATION

IB.16 Bid Opening, Clarification and Evaluation (SPP Rules 41, 42 & 43)

16.1 The Procuring Agency will open the bids, in the presence of bidders' representatives who choose to attend, at the time, date and in the place specified in the Bidding Data.

16.2 The bidder's name, Bid Prices, any discount, the presence or absence of Bid Security, and such other details as the Procuring Agency at its discretion may consider appropriate, will be announced by the Procuring Agency at the bid opening. The Procuring Agency will record the minutes of the bid opening. Representatives of the bidders who choose to attend shall sign the attendance sheet.

Any Bid Price or discount which is not read out and recorded at bid opening will not be taken into account in the evaluation of bid.

16.3 To assist in the examination, evaluation and comparison of Bids the Engineer/Procuring Agency may, at its discretion, ask the bidder for a clarification of its Bid. The request for clarification and the response shall be in writing and no change in the price or substance of the Bid shall be sought, offered or permitted (SPP Rule 43).

16.4 (a) Prior to the detailed evaluation, pursuant to IB.16.7 to 16.9, the Engineer/Procuring Agency will determine the substantial responsiveness of each bid to the Bidding Documents. For purpose of these instructions, a substantially responsive bid is one which conforms to all the terms and conditions of the Bidding Documents without material deviations. It will include determining the requirements listed in Bidding Data.

(b) Arithmetical errors will be rectified on the following basis:

If there is a discrepancy between the unit price and total price that is obtained by multiplying the unit price and quantity, the unit price shall prevail and the total price shall be corrected. If there is a discrepancy between the words and figures the amount in words shall prevail. If there is a discrepancy between the Total Bid price entered in Form of Bid and the total shown in Schedule of Prices-Summary, the amount stated in the Form of Bid will be corrected by the Procuring Agency in accordance with the Corrected Schedule of Prices.

If the bidder does not accept the corrected amount of Bid, his Bid will be rejected and his Bid Security forfeited.

16.5 A Bid determined as substantially non-responsive will be rejected and will not subsequently be made responsive by the bidder by correction of the non-conformity.

16.6 Any minor informality or non-conformity or irregularity in a Bid which does not constitute a material deviation (**major deviation**) may be waived by Procuring Agency, provided such waiver does not prejudice or affect the relative ranking of any other bidders.

(A). Major (material) Deviations include: -

- i has been not properly signed;
- ii is not accompanied by the bid security of required amount and manner;
- iii stipulating price adjustment when fixed price bids were called for;
- iv failing to respond to specifications;
- v failing to comply with Mile-stones/Critical dates provided in Bidding Documents;
- vi sub-contracting contrary to the Conditions of Contract specified in Bidding Documents;
- vii refusing to bear important responsibilities and liabilities allocated in the Bidding Documents, such as performance guarantees and insurance coverage;
- viii taking exception to critical provisions such as applicable law, taxes and duties and dispute resolution procedures;
- ix a material deviation or reservation is one :
 - a. which affect in any substantial way the scope, quality or performance of the works;
 - b. adoption/rectification whereof would affect unfairly the competitive position of other bidders presenting substantially responsive bids.

(B) Minor Deviations

Bids that offer deviations acceptable to the Procuring Agency and which can be assigned a monetary value may be considered substantially responsive at least as to the issue of fairness. This value would however be added as an adjustment for evaluation purposes only during the detailed evaluation process.

16.7 The Engineer/Procuring Agency will evaluate and compare only the bids previously determined to be substantially responsive pursuant to IB.16.4 to 16.6 as per requirements given hereunder. Bids will be evaluated for complete scope of works. The prices will be compared on the basis of the Evaluated Bid Price pursuant to IB.16.8 herein below.

Technical Evaluation: It will be examined in detail whether the works offered by the bidder complies with the Technical Provisions of the Bidding Documents. For this purpose, the bidder's data submitted with the bid in Schedule B to Bid will be compared with technical features/criteria of the works detailed

in the Technical Provisions. Other technical information submitted with the bid regarding the Scope of Work will also be reviewed.

16.8 Evaluated Bid Price

In evaluating the bids, the Engineer/Procuring Agency will determine for each bid in addition to the Bid Price, the following factors (adjustments) in the manner and to the extent indicated below to determine the Evaluated Bid Price:

- (i) making any correction for arithmetic errors pursuant to IB.16.4 hereof.
- (ii) discount, if any, offered by the bidders as also read out and recorded at the time of bid opening.
- (iii) excluding **provisional sums** and the provisions for **contingencies** in the Bill of Quantities **if any**, but including **Day work**, where priced competitively.

IB.17 Process to be Confidential

17.1 Subject to IB.16.3 heretofore, no bidder shall contact Engineer/Procuring Agency on any matter relating to its Bid from the time of the Bid opening to the time the bid evaluation result is announced by the Procuring Agency. The evaluation result shall be announced at least seven (07) days prior to award of Contract (SPP Rule 45). The announcement to all bidders will include table(s) comprising read out prices, discounted prices, price adjustments made, final evaluated prices and recommendations against all the bids evaluated.

17.2 Any effort by a bidder to influence Engineer/Procuring Agency in the Bid evaluation, Bid comparison or Contract Award decisions may result in the rejection of his Bid. Whereas any bidder feeling aggrieved, may lodge a written complaint to Complaint Redressal Committee as per terms and conditions mentioned in SPP Rules 31 & 32. However, mere fact of lodging a complaint shall not warrant suspension of procurement process.

17.3 Bidders may be excluded if involved in **“Corrupt and Fraudulent Practices”** means either one or any combination of the practices given below SPP Rule2(q);

- (i) —**Coercive Practice**|| means any impairing or harming, or threatening to impair or harm, directly or indirectly, any party or the property of the party to influence the actions of a party to achieve a wrongful gain or to cause a wrongful loss to another party;
- (ii) —**Collusive Practice**|| means any arrangement between two or more parties to the procurement process or contract execution, designed to achieve with or without the knowledge of the procuring agency to establish prices at artificial, noncompetitive levels for any wrongful gain; (iii) **“Corrupt Practice”** means the offering, giving, receiving or soliciting, directly or indirectly, of anything of value to influence the acts of another party for wrongful gain;
- (iv) —**Fraudulent Practice”** means any act or omission, including a misrepresentation, that knowingly or recklessly misleads, or attempts to mislead, a party to obtain a financial or other benefit or to avoid an obligation.

(v) **“Obstructive Practice”** means harming or threatening to harm, directly or indirectly, persons or their property to influence their participation in a procurement process, or affect the execution of a contract or deliberately destroying, falsifying, altering or concealing of evidence material to the investigation or making false statements before investigators in order to materially impede an investigation into allegations of a corrupt, fraudulent, coercive or collusive practice; or threatening, harassing or intimidating any party to prevent it from disclosing its knowledge of matters relevant to the investigation or from pursuing the investigation, or acts intended to materially impede the exercise of inspection and audit rights provided for under the Rules.

F. AWARD OF CONTRACT IB.18. Post Qualification

18.1 The Procuring Agency, at any stage of the bid evaluation, having credible reasons for or *prima facie* evidence of any defect in contractor ‘s capacities, may require the contractors to provide information concerning their professional, technical, financial, legal or managerial competence whether already pre-qualified or not:

Provided, that such qualification shall only be laid down after recording reasons therefore in writing. They shall form part of the records of that bid evaluation report.

18.2 The determination will take into account the bidder’s financial and technical capabilities. It will be based upon an examination of the documentary evidence of the bidders’ qualifications submitted under B.11, as well as such other information required in the Bidding Documents.

IB.19 Award Criteria & Procuring Agency’s Right

19.1 Subject to IB.19.2, the Procuring Agency will award the Contract to the bidder whose bid has been determined to be substantially responsive to the Bidding Documents and who has offered the lowest evaluated Bid Price, provided that such bidder has been determined to be qualified to satisfactory perform the Contract in accordance with the provisions of the IB.18.

19.2 Notwithstanding IB.19.1, the Procuring Agency reserves the right to accept or reject any bid, and to annul the bidding process and reject all bids, at any time prior to award of Contract, without thereby incurring any liability to the affected bidders or any obligation to inform the affected bidders of the grounds for the Procuring Agency’s action except that the grounds for its rejection of all bids shall upon request be communicated, to any bidder who submitted a bid, without justification of the grounds. Notice of the rejection of all the bids shall be given promptly to all the bidders (SPP Rule 25).

IB.20 Notification of Award & Signing of Contract Agreement

20.1 Prior to expiration of the period of bid validity prescribed by the Procuring Agency, the Procuring Agency will notify the successful bidder in writing (—Letter of Acceptance||) that his bid has been accepted (SPP Rule 49).

20.2 Within seven (07) days from the date of furnishing of acceptable Performance Security under the Conditions of Contract, the Procuring Agency will send the successful bidder the Form of Contract Agreement provided in the Bidding Documents, incorporating all agreements between the parties.

20.3 The formal Agreement between the Procuring Agency and the successful bidder duly stamped at rate of ---% of bid price(updated from time to time) stated in Letter of Acceptance shall be executed within seven (07) days of the receipt of Form of Contract Agreement by the successful bidder from the Procuring Agency.

IB.21 Performance Security

21.1 The successful bidder shall furnish to the Procuring Agency a Performance Security in the form and the amount stipulated in the Conditions of Contract within a period of fourteen (14) days after the receipt of Letter of Acceptance (SPP 39).

21.2 Failure of the successful bidder to comply with the requirements of Sub-Clauses IB.20.2 & 20.3 or 21.1 or Clause IB.22 shall constitute sufficient grounds for the annulment of the award and forfeiture of the Bid Security.

21.3 Publication of Award of Contract: within seven days of the award of contract, the procuring shall publish on the website of the authority and on its own website, if such a website exists, the results of the bidding process, identifying the bid through procurement identifying Number if any and the following information:

- (1) Evaluation Report;
- (2) Form of Contract and letter of Award;
- (3) Bill of Quantities or Schedule of Requirements. (SPP Rule 50)

IB.22 Integrity Pact The Bidder shall sign and stamp the Form of Integrity Pact provided at Schedule-F to Bid in the Bidding Document for all Sindh Government procurement contracts exceeding Rupees ten (10) million. Failure to provide such Integrity Pact shall make the bid nonresponsive (SPP Rule 89).

BIDDING DATA

- (a) Name of Procuring Agency:** Institute of Business Administration, Karachi
- (b) Brief Description of Works:** Construction of Main Gate No. 1 at IBA Main Campus
- (c) Procuring Agency's address:-**Main Campus, University Enclave, Karachi
- (d) Amount of Bid Security:-** Bid Security of 2% of total amount/cost will be submitted along with Tender Documents in shape of PAY ORDER / DEMAND DRAFT only in the name of Institute of Business Administration, Karachi.
- (e) Period of Bid Validity (days):** Ninety Days
- (f) Performance Security Deposit:** Successful bidder should provide 5% Performance Security of total value of Work Order in the form of Pay Order or bank guarantee after acceptance of the Work Order. The Performance Security shall extend at least three months beyond the Date of Delivery/Completion of work / Contract.
- (g) Deadline for Submission of Bids along with time:** The last date of submit the Tender Document in sealed envelope in July 24, 2024 by 3:00 PM in the Office of Head of Procurement, Ground Floor, Fauji Foundation Building, IBA Main Campus, University Enclave, Karachi. The Tender will be opened on same day at 3:30 PM in the presence of representatives who may care to attend.
- (h) Venue, Time, and Date of Bid Opening:** Tender will be opened on July 24, 2024, on 3:30 PM at IBA, Main Campus, University Enclave, Karachi.
- (i) Time for Completion from written order of commence:** 60 days.
- (j) Liquidated damages:** 2% liquidated damages of the total amount will be imposed per week for which the company/firm/agency failed to complete work within the delivery/execution period and maximum up to 10%.
- (k) Deposit Receipt No: Date: Amount:(in words and figures) Pay Order / Demand Draft**
 # _____, Amount Rs _____ Drawn on Bank _____ Dated _____.

16.4 Responsiveness of Bids

(i) Bid is valid till required period,

*(ii) Bid prices are firm during currency of contract/Price adjustment;

(iii) Completion period offered is within specified limits,

(iv) Bidder is eligible to Bid and possesses the requisite experience, capability, and qualification.

(v) Bid does not deviate from basic technical requirements and

(vi) Bids are generally in order, etc.

*Procuring agency can adopt either of two options. *(Select either of them)*

(a) **Fixed Price contract:** In these contracts no escalation will be provided during currency of the contract and normally period of completion of these works is upto 12 months.

(b) **Price adjustment contract:** In these contracts' escalation will be paid only on those items and in the manner as notified by Finance Department, Government of Sindh, after bid opening during currency of the contract.

FORM OF BID AND SCHEDULES TO BID

FORM OF BID
(LETTER OF OFFER)

Bid Reference No. _____

(Name of Works)

To:

Gentlemen,

1. Having examined the Bidding Documents including Instructions to Bidders, Bidding Data, Conditions of Contract, Contract Data, Specifications, Drawings, if any, Schedule of Prices and Addenda Nos.

_____ for the execution of the above-named works, we, the undersigned, being a company doing business under the name of and address _____

_____ and being duly incorporated under the laws of Pakistan hereby offer to execute and complete such works and remedy any defects therein in conformity with the said Documents including Addenda thereto for the Total Bid Price of Rs _____ (Rupees _____) or such other sum as may be ascertained in accordance with the said Documents.

2. We understand that all the Schedules attached hereto form part of this Bid.

3. As security for due performance of the undertakings and obligations of this Bid, we submit herewith a Bid Security in the amount of _____ drawn in your favor or made payable to you and valid for a period of twenty eight (28) days beyond the period of validity of Bid.

4. We undertake, if our Bid is accepted, to commence the Works and to deliver and complete the Works comprised in the Contract within the time(s) stated in Contract Data.

5. We agree to abide by this Bid for the period of _____ days from the date fixed for receiving the same and it shall remain binding upon us and may be accepted at any time before the expiration of that period.

6. Unless and until a formal Agreement is prepared and executed, this Bid, together with your written acceptance thereof, shall constitute a binding contract between us.

7. We undertake, if our Bid is accepted, to execute the Performance Security referred to in Conditions of Contract for the due performance of the Contract.

8. We understand that you are not bound to accept the lowest or any bid you may receive.

9. We do hereby declare that the Bid is made without any collusion, comparison of figures or arrangement with any other person or persons making a bid for the Works.

Dated this _____ day of _____, 20

Signature _____

in the capacity of _____ duly authorized to sign bid for and on behalf of

(Name of Bidder in Block Capitals)

(Seal)

Address

Witness:

(Signature) _____

Name: _____

Address: _____

[SCHEDULES TO BID INCLUDE THE FOLLOWING:

- Schedule A to Bid: Schedule of Prices
- Schedule B to Bid: Specific Works Data
- Schedule C to Bid: Works to be Performed by Subcontractors
- Schedule D to Bid: Proposed Program of Works
- Schedule E to Bid: Method of Performing Works
- Schedule F to Bid: Integrity Pact]

SCHEDULE – A TO BID

SCHEDULE OF PRICES

<u>Sr. No.</u>		<u>Page No.</u>
1.	Preamble to Schedule of Prices.....	24
2.	Schedule of Prices.....	26
	* (a) Summary of Bid Prices	
*	(b) Detailed Schedule of Prices /Bill of Quantities (BOQ)	

PREAMBLE TO SCHEDULE OF PRICES

1. General

1.1 The Schedule of Prices shall be read in conjunction with the Conditions of Contract, Contract Data together with the Specifications and Drawings, if any.

1.2 The Contract shall be for the whole of the works as described in these Bidding Documents. Bids must be for the complete scope of works.

2. Description

2.1 The general directions and descriptions of works and materials are not necessarily repeated nor summarized in the Schedule of Prices. References to the relevant sections of the Bidding Documents shall be made before entering prices against each item in the Schedule of Prices.

3. Units & Abbreviations

3.1 Units of measurement, symbols and abbreviations expressed in the Bidding Documents shall comply with the System International d' Unites (SI Units).

(Note: The abbreviations to be used in the Schedule of Prices to be defined by the Procuring Agency).

4. Rates and Prices

4.1 Except as otherwise expressly provided under the Conditions of Contract, the rates and amounts entered in the Schedule of Prices shall be the rates at which the Contractor shall be paid and shall be the full inclusive value of the works set forth or implied in the Contract; except for the amounts reimbursable, if any to the Contractor under the Contract.

4.2 Unless otherwise stipulated in the Contract Data, the premium, rates and prices entered by the bidder shall not be subject to adjustment during the performance of the Contract.

4.3 All duties, taxes and other levies payable by the Contractor shall be included in the rates and prices.

4.4 The whole cost of complying with the provisions of the Contract shall be included in the items provided in the Schedule of Prices, and where

no items are provided, the cost shall be deemed to be distributed among the rates and prices entered for the related items of the Works and no separate payment will be made for those items.

The rates, prices and amounts shall be entered against each item in the Schedule of Prices. Any item against which no rate or price is entered by the bidder will not be paid for by the Procuring Agency when executed and shall be deemed covered by the rates and prices for other items in the Schedule of Prices.

4.5 (a) The bidder shall be deemed to have obtained all information as to and all requirements related thereto which may affect the bid price.

*(b) The Contractor shall be responsible to make complete arrangements for the transportation of the Plant to the Site.

**(Procuring Agency may modify as appropriate)*

4.6 The Contractor shall provide for all parts of the Works to be completed in every respect. Notwithstanding that any details, accessories, etc. required for the complete installation and satisfactory operation of the Works, are not specifically mentioned in the Specifications, such details shall be considered as included in the Contract Price.

5. Bid Prices

5.1 Break-up of Bid Prices

The various elements of Bid Prices shall be quoted as detailed by the Procuring Agency in the format of Schedule of Prices.

The bidder shall recognize such elements of the costs which he expects to incur the performance of the Works and shall include all such costs in the rates and amounts entered in the Schedule of Prices.

5.2 Total Bid Price

The total of bid prices in the Schedule of Prices shall be entered in the Summary of Bid Prices.

6. Provisional Sums and Day work

6.1 Provisional Sums included and so designated in the Schedule of Prices if any, shall be expended in whole or in part at the direction and discretion of the Engineer/Procuring Agency. The Contractor will only receive payment in respect of Provisional Sums, if he has been instructed by the Engineer/Procuring Agency to utilize such sums.

6.2 Day work rates in the contractor’s bid are to be used for small additional amounts of work and only when the Engineer have given written instructions in advance for additional work to be paid for in that way.

WORKS TO BE PERFORMED BY SUBCONTRACTORS*

The bidder will do the work with his own forces except the work listed below which he intends to sub-contract.

Items of Works similar to be Sub-Contracted previously	Name and address of Sub-Contractors	Statement of works executed. <i>(attach evidence)</i>
--	--	--

Note:

* *The Procuring Agency should decide whether to allow subcontracting or not.*

In case Procuring Agency decides to allow subcontracting then following conditions shall be complied with:

1. No change of Sub-Contractors shall be made by the bidder without prior approval of the Procuring Agency.
2. The truthfulness and accuracy of the statement as to the experience of Sub-

Contractors is guaranteed by the bidder. The Procuring Agency’s judgment shall be final as to the evaluation of the experience of Sub-Contractors submitted by the bidder.

3. Statement of similar works shall include description, location & value of works, year completed and name & address of the clients.

D TO BID

PROPOSED PROGRAMME OF WORKS

Bidder shall provide a program in a bar-chart or Program Evaluation and Review Technique (PERT) or Critical Path Method (CPM) showing the sequence of work items by which he proposes to complete the works of the entire Contract. The program should indicate the sequence of work items and the period of time during which he proposes to complete the works including the activities like designing, schedule of submittal of drawings, ordering and procurement of materials, manufacturing, delivering, construction of civil works, erection, testing and commissioning of works to be supplied under the Contract.

E TO BID

METHOD OF PERFORMING WORKS

The bidder is required to submit a narrative outlining the method of performing the Works. The narrative should indicate in detail and include but not be limited to:

- The sequence and methods in which he proposes to carry out the Works, including the number of shifts per day and hours per shift, he expects to work.
- A list of all major items of construction and plant erection, tools and vehicles proposed to be used in delivering/carrying out the works at site.
- The procedure for installation of equipment and transportation of equipment and materials to the site.
- Organization chart indicating head office & field office personnel involved in management, supervision and engineering of the Works to be done under the Contract.

F TO BID

(INTEGRITY PACT)

**DECLARATION OF FEES, COMMISSION AND BROKERAGE ETC
PAYABLE BY CONTRACTORS
(FOR CONTRACTS WORTH RS. 10.00 MILLION OR MORE)**

Contract No. _____ Dated _____

Contract Value: _____

Contract Title: _____

..... [name of Contractor] hereby declares that it has not obtained or induced the procurement of any contract, right, interest, privilege or other obligation or benefit from Government of Sindh (GoS) or any administrative subdivision or agency thereof or any other entity owned or controlled by it (GoS) through any corrupt business practice.

Without limiting the generality of the foregoing, [name of Contractor] represents and warrants that it has fully declared the brokerage, commission, fees etc. paid or payable to anyone and not given or agreed to give and shall not give or agree to give to anyone within or outside Pakistan either directly or indirectly through any natural or juridical person, including its affiliate, agent, associate, broker, consultant, director, promoter, shareholder, sponsor or subsidiary, any commission, gratification, bribe, finder’s fee or kickback, whether described as consultation fee or otherwise, with the object of obtaining or inducing the procurement of a contract, right, interest, privilege or other obligation or benefit in whatsoever form from, from Procuring Agency (PA) except that which has been expressly declared pursuant hereto.

[name of Contractor] accepts full responsibility and strict liability that it has made and will make full disclosure of all agreements and arrangements with all persons in respect of or related to the transaction with PA and has not taken any action or will not take any action to circumvent the above declaration, representation or warranty.

[name of Contractor] accepts full responsibility and strict liability for making any false declaration, not making full disclosure, misrepresenting facts or taking any action likely to defeat the purpose of this declaration, representation and warranty. It agrees that any contract, right, interest, privilege or other obligation or benefit obtained or procured as aforesaid shall, without prejudice to any other rights and remedies available to PA under any law, contract or other instrument, be voidable at the option of PA.

Notwithstanding any rights and remedies exercised by PA in this regard, [name of Supplier/Contractor/Consultant] agrees to indemnify PA for any loss or damage incurred by it on account of its corrupt business practices and further pay compensation to PA in an amount equivalent to ten time the sum of any commission, gratification, bribe, finder’s fee or kickback given by [name of Contractor] as aforesaid for the purpose of obtaining or inducing the procurement of any contract, right, interest, privilege or other obligation or benefit in whatsoever form from PA.

.....
[Procuring Agency]

[Contractor]

TABLE OF CONTENTS

CONDITIONS OF CONTRACT

<i>Clause No</i>	<i>Description</i>	<i>Page No</i>
1.	General Provisions.....	35
2.	The Procuring Agency.....	37
3.	Engineer's/Procuring Agency's Representatives.....	37
4.	The Contractor.....	38
5.	Design by Contractor.....	38
6.	Procuring Agency's Risks.....	39
7.	Time for Completion.....	40
8.	Taking Over.....	41
9.	Remedying Defects.....	41
10.	Variations and Claims.....	41
11.	Contract Price And Payment.....	43
12.	Default.....	44
13.	Risks and Responsibilities.....	46
14.	Insurance.....	46
15.	Resolution of Disputes.....	47
16.	Integrity Pact.....	48

CONDITIONS OF CONTRACT

1. GENERAL PROVISIONS

1.1 Definitions

In the Contract as defined below, the words and expressions defined shall have the following meanings assigned to them, except where the context requires otherwise:

The Contract

1.1.1 —Contract|| means the Contract Agreement and the other documents listed in the Contract Data.

1.1.2 —Specifications|| means the document as listed in the Contract Data, including Procuring Agency's requirements in respect of design to be carried out by the Contractor (if any), and any Variation to such document.

1.1.3 —Drawings|| means the Procuring Agency's drawings of the Works as listed in the Contract Data, and any Variation to such drawings.

Persons

1.1.4 —Procuring Agency|| means the person named in the Contract Data and the legal successors in title to this person, but not (except with the consent of the Contractor) any assignee.

1.1.5 —Contractor|| means the person named in the Contract Data and the legal successors in title to this person, but not (except with the consent of the Procuring Agency) any assignee.

1.1.6 —Party|| means either the Procuring Agency or the Contractor.

Dates, Times and Periods

1.1.7 —Commencement Date|| means the date fourteen (14) days after the date the Contract comes into effect or any other date named in the Contract Data.

1.1.8 —Day|| means a calendar day

1.1.9 —Time for Completion|| means the time for completing the Works as stated in the Contract Data (or as extended under Sub-Clause 7.3), calculated from the Commencement Date.

Money and Payments

1.1.10 —Cost|| means all expenditure properly incurred (or to be incurred) by the Contractor, whether on or off the Site, including overheads and similar charges but does not include any allowance for profit.

Other Definitions

1.1.11 —Contractor's Equipment|| means all machinery, apparatus and other things required for the execution of the Works but does not include Materials or Plant intended to form part of the Works.

1.1.12 —Country|| means the Islamic Republic of Pakistan.

1.1.13 —Procuring Agency's Risks|| means those matters listed in Sub-Clause 6.1.

1.1.14 —Force Majeure|| means an event or circumstance which makes performance of a Party's obligations illegal or impracticable and which is beyond that Party's reasonable control.

1.1.15 —Materials|| means things of all kinds (other than Plant) to be supplied and incorporated in the Works by the Contractor.

1.1.16 —Plant|| means the machinery and apparatus intended to form or forming part of the Works.

1.1.17 —Site|| means the places provided by the Procuring Agency where the Works are to be executed, and any other places specified in the Contract as forming part of the Site.

1.1.18 —Variation|| means a change which is instructed by the Engineer/Procuring Agency under Sub-Clause 10.1.

1.1.19 —Works|| means any or all the works whether Supply, Installation, Construction etc. and design (if any) to be performed by the Contractor including temporary works and any variation thereof.

1.1.20 —Engineer|| means the person notified by the Procuring Agency to act as Engineer for the purpose of the Contract and named as such in Contract Data.

1.2 Interpretation

Words importing persons or parties shall include firms and organizations. Words importing singular or one gender shall include plural or the other gender where the context requires.

1.3 Priority of Documents

The documents forming the Contract are to be taken as mutually explanatory of one another. If an ambiguity or discrepancy is found in the documents, the priority of the documents shall be in accordance with the order as listed in the Contract Data.

1.4 Law

The law of the Contract is the relevant Law of Islamic Republic of Pakistan.

1.5 Communications

All Communications related to the Contract shall be in English language.

1.6 Statutory Obligations

The Contractor shall comply with the Laws of Islamic Republic of Pakistan and shall give all notices and pay all fees and other charges in respect of the Works.

2. THE PROCURING AGENCY

2.1 Provision of Site

The Procuring Agency shall provide the Site and right of access thereto at the times stated in the Contract Data.

Site Investigation Reports are those that were included in the bidding documents and are factual and interpretative reports about the surface and subsurface conditions at the Site.

2.2 Permits etc.

The Procuring Agency shall, if requested by the Contractor, assist him in applying for permits, licences or approvals which are required for the Works.

2.3 Engineer's/Procuring Agency's Instructions

The Contractor shall comply with all instructions given by the Procuring Agency or the Engineer, if notified by the Procuring Agency, in respect of the Works including the suspension of all or part of the works.

2.4 Approvals

No approval or consent or absence of comment by the Engineer/Procuring Agency shall affect the Contractor's obligations.

3. ENGINEER'S/PROCURING AGENCY'S REPRESENTATIVES

3.1 Authorized Person

The Procuring Agency shall appoint a duly authorized person to act for him and on his behalf for the purposes of this Contract. Such authorized person shall be duly identified in the Contract Data or otherwise notified in writing to the Contractor as soon as he is so appointed. In either case the Procuring Agency shall notify the Contractor, in writing, the precise scope of the authority of such authorized person at the time of his appointment.

3.2 Engineer's/Procuring Agency's Representative

The name and address of Engineer's/Procuring Agency's Representative is given in Contract Data. However the Contractor shall be notified by the Engineer/Procuring Agency, the delegated duties and authority before the Commencement of works.

4. THE CONTRACTOR

4.1 General Obligations

The Contractor shall carry out the works properly and in accordance with the Contract. The Contractor shall provide all supervision, labour, Materials, Plant and Contractor's Equipment which may be required

4.2 Contractor's Representative

The Contractor shall appoint a representative at site on full time basis to supervise the execution of work and to receive instructions on behalf of the Contractor but only after obtaining the consent of the Procuring Agency for such appointment which consent shall not be withheld without plausible reason(s) by the Procuring Agency. Such authorized representative may be substituted/ replaced by the Contractor at any time during the Contract Period but only after obtaining the consent of the Procuring Agency as aforesaid.

4.3 Subcontracting

The Contractor shall not subcontract the whole of the works. The Contractor shall not subcontract any part of the works without the consent of the Procuring Agency.

4.4 Performance Security

The Contractor shall furnish to the Procuring Agency within fourteen (14) days after receipt of Letter of Acceptance a Performance Security at the option of the bidder, in the form of Payee's order /Bank Draft or Bank Guarantee from scheduled bank for the amount and validity specified in Contract Data.

5. DESIGN BY CONTRACTOR

5.1 Contractor's Design

The Contractor shall carry out design to the extent specified, as referred to in the Contract Data. The Contractor shall promptly submit to the Engineer/Procuring Agency all designs prepared by him, within fourteen (14) days of receipt the Engineer/Procuring Agency shall notify any comments or, if the design submitted is not in accordance with the Contract, shall reject it stating the reasons. The Contractor shall not construct any element of the works designed by him within fourteen (14) days after the design has been submitted to the Engineer/Procuring Agency or which has been rejected. Design that has been rejected shall be promptly amended and resubmitted. The Contractor shall resubmit all designs commented on taking these comments into account as necessary.

5.2 Responsibility for Design

The Contractor shall remain responsible for his bided design and the design under this Clause, both of which shall be fit for the intended purposes defined in the Contract and he shall also remain responsible for any infringement of any patent or copyright in respect of the same. The Engineer/Procuring Agency shall be responsible for the Specifications and Drawings.

6. PROCURING AGENCY'S RISKS

6.1 The Procuring Agency's Risks

The Procuring Agency's Risks are:-

- a)** war, hostilities (whether war be declared or not), invasion, act of foreign enemies, within the Country;
- b)** rebellion, terrorism, revolution, insurrection, military or usurped power, or civil war, within the Country;
- c)** riot, commotion or disorder by persons other than the Contractor's personnel and other employees including the personnel and employees of Sub Contractors, affecting the Site and/or the Works;
- d)** ionizing radiations, or contamination by radio-activity from any nuclear fuel, or from any nuclear waste from the combustion of nuclear fuel, radio-active toxic explosive, or other hazardous properties of any explosive nuclear assembly or nuclear component of such an assembly, except to the extent to which the Contractor/Sub-Contractors may be responsible for the use of any radio-active material;
Pressure waves caused by aircraft or other aerial devices travelling at sonic or supersonic speeds;

- e) use or occupation by the Procuring Agency of any part of the Works, except as may be specified in the Contract;
- f) late handing over of sites, anomalies in drawings, late delivery of designs and drawings of any part of the Works by the Procuring Agency's personnel or by others for whom the Procuring Agency is responsible;
- g) a suspension under Sub-Clause 2.3 unless it is attributable to the Contractor's failure; and
- h) physical obstructions or physical conditions other than climatic conditions, encountered on the Site during the performance of the Works, for which the Contractor immediately notified to the Procuring Agency and accepted by the Procuring Agency.

7. TIME FOR COMPLETION

7.1 Execution of the Works

The Contractor shall commence the Works on the Commencement Date and shall proceed expeditiously and without delay and shall complete the Works, subject to Sub-Clause 7.3 below, within the Time for Completion.

7.2 Program

Within the time stated in the Contract Data, the Contractor shall submit to the Engineer/Procuring Agency a program for the Works in the form stated in the Contract Data.

7.3 Extension of Time

The Contractor shall, within such time as may be reasonable under the circumstances, notify the Procuring Agency/Engineer of any event(s) falling within the scope of Sub-Clause 6.1 or 10.3 of these Conditions of Contract and request the Procuring Agency/Engineer for a reasonable extension in the time for the completion of works. Subject to the aforesaid, the Procuring Agency/Engineer shall determine such reasonable extension in the time for the completion of works as may be justified in the light of the details/particulars supplied by the Contractor in connection with the such determination by the Procuring Agency/Engineer within such period as may be prescribed by the Procuring Agency/Engineer for the same; and the Procuring Agency may extend the time for completion as determined.

7.4 Late Completion

If the Contractor fails to complete the Works within the Time for Completion, the Contractor's only liability to the Procuring Agency for such failure shall be to pay the amount as **liquidity damages** stated in the Contract Data for each day for which he fails to complete the Works.

8. TAKING-OVER

8.1 Completion

The Contractor may notify the Engineer/Procuring Agency when he considers that the Works are complete.

8.2 Taking-Over Notice

Within fourteen (14) days of the receipt of the said notice of completion from the Contractor the Procuring Agency/Engineer shall either takeover the completed works and issue a Certificate of Completion to that effect or shall notify the Contractor his reasons for not taking-over the works. While issuing the Certificate of Completion as aforesaid, the Procuring Agency/Engineer may identify any outstanding items of work which the Contractor shall undertake during the Maintenance Period.

9. REMEDYING DEFECTS

9.1 Remediating Defects

The Contractor shall for a period stated in the Contract Data from the date of issue of the Certificate of Completion carry out, at no cost to the Procuring Agency, repair and rectification work which is necessitated by the earlier execution of poor quality of work or use of below specifications material in the execution of Works and which is so identified by the Procuring Agency/Engineer in writing within the said period. Upon expiry of the said period, and subject to the Contractor's faithfully performing his aforesaid obligations, the Procuring Agency/Engineer shall issue a Maintenance Certificate whereupon all obligations of the Contractor under this Contract shall come to an end.

Failure to remedy any such defects or complete outstanding work within a reasonable time shall entitle the Procuring Agency to carry out all necessary works at the Contractor's cost. However, the cost of remedying defects not attributable to the Contractor shall be valued as a Variation.

9.2 Uncovering and Testing

The Engineer/Procuring Agency may give instruction as to the uncovering and/or testing of any work. Unless as a result of an uncovering and/or testing it is established that the Contractor's design, materials, plant or workmanship are not in accordance with the Contract, the Contractor shall be paid for such uncovering and/or testing as a Variation in accordance with Sub-Clause 10.2.

10. VARIATIONS AND CLAIMS**10.1 Right to Vary**

The Procuring Agency/Engineer may issue Variation Order(s) in writing. Where for any reason it has not been possible for the Procuring Agency/Engineer to issue such Variations Order(s), the Contractor may confirm any verbal orders given by the Procuring Agency/Engineer in writing and if the same are not refuted/denied by the Procuring Agency/Engineer within ten (10) days of the receipt of such confirmation the same shall be deemed to be a Variation Orders for the purposes of this Sub-Clause.

10.2 Valuation of Variations

Variations shall be valued as follows:

- a) at a lump sum price agreed between the Parties, or
- b) where appropriate, at rates in the Contract, or
- c) in the absence of appropriate rates, the rates in the Contract shall be used as the basis for valuation, or failing which
- d) at appropriate new rates, as may be agreed or which the Engineer/Procuring Agency considers appropriate, or
- e) if the Engineer/Procuring Agency so instructs, at day work rates set out in the Contract Data for which the Contractor shall keep records of hours of labour and Contractor's Equipment, and of Materials, used.

10.3 Changes in the Quantities.

- a) If the final quantity of the work done differs from the quantity in the Bill of Quantities for the particular item by more than 25 percent, provided the change exceeds 1 percent of the Initial Contract Price, the Procuring Agency/Engineer shall adjust the rate to allow for the change and will be valued as per sub clause 10.2.
- b) The Engineer shall not adjust rates from changes in quantities if thereby the Initial Contract Price is exceeded by more than 15 percent, except with the prior approval of the Procuring Agency.
- c) If requested by the Engineer, the contractor shall provide the Engineer with a detailed cost breakdown of any rate in the Bill of Quantities.

10.4 **Early Warning**

The Contractor shall notify the Engineer/Procuring Agency in writing as soon as he is aware of any circumstance which may delay or disrupt the Works, or which may give rise to a claim for additional payment.

To the extent of the Contractor's failure to notify, which results to the Engineer/Procuring Agency being unable to keep all relevant records or not taking steps to minimize any delay, disruption, or Cost, or the value of any Variation, the Contractor's entitlement to extension of the Time for Completion or additional payment shall be reduced/rejected.

10.5 **Valuation of Claims**

If the Contractor incurs Cost as a result of any of the Procuring Agency's Risks, the Contractor shall be entitled to the amount of such Cost. If as a result of any Procuring Agency's Risk, it is necessary to change the Works, this shall be dealt with as a Variation subject to Contractor's notification for intention of claim to the Engineer/Procuring Agency within fourteen (14) days of the occurrence of cause.

10.6 **Variation and Claim Procedure**

The Contractor shall submit to the Engineer/Procuring Agency an itemized detailed breakdown of the value of variations and claims within twenty eight (28) days of the instruction or of the event giving rise to the claim. The Engineer/Procuring Agency shall check and if possible agree the value. In the absence of agreement, the Procuring Agency shall determine the value.

11. **CONTRACT PRICE AND PAYMENT**

11.1 (a) **Terms of Payments**

The amount due to the Contractor under any Interim Payment Certificate issued by the Engineer pursuant to this Clause, or to any other terms of the Contract, shall, subject to Clause 11.3, be paid by the Procuring Agency to the Contractor within 30 days after such Interim Payment Certificate has been jointly verified by Procuring Agency and Contractor, or, in the case of the Final Certificate referred to in Sub Clause 11.5, within 60 days after such Final Payment Certificate has been jointly verified by Procuring Agency and Contractor;

Provided that the Interim Payment shall be caused in thirty (30) days and Final Payment in 60 days in case of foreign funded project. In the event of the failure of the Procuring Agency to make payment within 90 days then Procuring Agency shall pay to the Contractor compensation at the 28 days rate of KIBOR+2% per annum in local currency and LIBOR+1% for foreign currency, upon all sums unpaid from the date by which the same should have been paid.

(b) **Valuation of the Works**

The Works shall be valued as provided for in the Contract Data, subject to Clause 10.

11.2 Monthly Statements

The Contractor shall be entitled to be paid at monthly intervals:

- a) the value of the Works executed less to the cumulative amount paid previously; and
- b) value of secured advance on the materials and valuation of variations (if any).

The Contractor shall submit each month to the Engineer/Procuring Agency a statement showing the amounts to which he considers himself entitled.

11.3 Interim Payments

Within a period not exceeding seven (07) days from the date of submission of a statement for interim payment by the Contractor, the Engineer shall verify the same and within a period not exceeding thirty (30/60) days from the said date of submission by the Contractor, the Procuring Agency shall pay to the Contractor the sum subject to adjustment for deduction of the advance payments and retention money.

11.4 Retention

Retention money shall be paid by the Procuring Agency to the Contractor within fourteen (14) days after either the expiry of the period stated in the Contract Data, or the remedying of notified defects, or the completion of outstanding work, all as referred to in Sub-Clause 9.1, whichever is the later.

11.5 Final Payment

Within twenty one (21) days from the date of issuance of the Maintenance Certificate the Contractor shall submit a final account to the Engineer to verify and the Engineer shall verify the same within fourteen (14) days from the date of submission and forward the same to the Procuring Agency together with any documentation reasonably required to enable the Procuring Agency to ascertain the final contract value.

Within sixty (60) days from the date of receipt of the verified final account from the Engineer, the Procuring Agency shall pay to the Contractor any amount due to the Contractor. While making such payment the Procuring Agency may, for reasons to be given to the Contractor in writing, withhold any part or parts of the verified amount.

11.6 Currency

Payment shall be in the currency stated in the Contract Data.

12. DEFAULT

12.1 Defaults by Contractor

If the Contractor abandons the Works, refuses or fails to comply with a valid instruction of the Engineer/Procuring Agency or fails to proceed expeditiously and without delay, or is, despite a written complaint, in breach of the Contract, the Procuring Agency may give notice referring to this Sub-Clause and stating the default.

If the Contractor has not taken all practicable steps to remedy the default within fourteen (14) days after receipt of the Procuring Agency's notice, the Procuring Agency may by a second notice given within a further twenty one (21) days, terminate the Contract. The Contractor shall then demobilize from the Site leaving behind any Contractor's Equipment which the Procuring Agency instructs, in the second notice, to be used for the completion of the Works at the risk and cost of the Contractor.

12.2 Defaults by Procuring Agency

If the Procuring Agency fails to pay in accordance with the Contract, or is, despite a written complaint, in breach of the Contract, the Contractor may give notice referring to this Sub-Clause and stating the default. If the default is not remedied within fourteen (14) days after the Procuring Agency's receipt of this notice, the Contractor may suspend the execution of all or parts of the Works.

If the default is not remedied within twenty eight (28) days after the Procuring Agency's receipt of the Contractor's notice, the Contractor may by a second notice given within a further twenty one (21) days, terminate the Contract. The Contractor shall then demobilize from the Site.

12.3 Insolvency

If a Party is declared insolvent under any applicable law, the other Party may by notice terminate the Contract immediately. The Contractor shall then demobilize from the site leaving behind, in the case of the Contractor's insolvency, any Contractor's Equipment which the Procuring Agency instructs in the notice is to be used for the completion of the Works.

12.4 Payment upon Termination

After termination, the Contractor shall be entitled to payment of the unpaid balance of the value of the works executed and of the Materials and Plant reasonably delivered to the site, adjusted by the following:

- a) any sums to which the Contractor is entitled under Sub-Clause 10.4,
- b) any sums to which the Procuring Agency is entitled,

c) if the Procuring Agency has terminated under Sub-Clause 12.1 or 12.3, the Procuring Agency shall be entitled to a sum equivalent to twenty percent (20%) of the value of parts of the Works not executed at the date of the termination, and

d) if the Contractor has terminated under Sub-Clause 12.2 or 12.3, the Contractor shall be entitled to the cost of his demobilization together with a sum equivalent to ten percent (10%) of the value of parts of the works not executed at the date of termination.

The net balance due shall be paid or repaid within twenty eight (28) days of the notice of termination.

13. RISKS AND RESPONSIBILITIES

13.1 Contractor's Care of the Works

Subject to Sub-Clause 9.1, the Contractor shall take full responsibility for the care of the Works from the Commencement Date until the date of the Procuring Agency's/Engineer's issuance of Certificate of Completion under Sub-Clause 8.2. Responsibility shall then pass to the Procuring Agency. If any loss or damage happens to the Works during the above period, the Contractor shall rectify such loss or damage so that the Works conform with the Contract.

Unless the loss or damage happens as a result of any of the Procuring Agency's Risks, the Contractor shall indemnify the Procuring Agency, or his agents against all claims loss, damage and expense arising out of the Works.

13.2 Force Majeure

If Force Majeure occurs, the Contractor shall notify the Engineer/Procuring Agency immediately. If necessary, the Contractor may suspend the execution of the Works and, to the extent agreed with the Procuring Agency demobilize the Contractor's Equipment.

If the event continues for a period of eighty four (84) days, either Party may then give notice of termination which shall take effect twenty eight (28) days after the giving of the notice.

After termination, the Contractor shall be entitled to payment of the unpaid balance of the value of the Works executed and of the Materials and Plant reasonably delivered to the Site, adjusted by the following:

- a) any sums to which the Contractor is entitled under Sub-Clause 10.4,
- b) the cost of his demobilization, and
- c) less any sums to which the Procuring Agency is entitled.

The net balance due shall be paid or repaid within thirty-five (35) days of the notice of termination.

14. INSURANCE

14.1 Arrangements

The Contractor shall, prior to commencing the Works, effect insurances of the types, in the amounts and naming as insured the persons stipulated in the Contract Data except for items (a) to (e) and (i) of the Procuring Agency's Risks under SubClause 6.1. The policies shall be issued by insurers and in terms approved by the Procuring Agency. The Contractor shall provide the Engineer/Procuring Agency with evidence that any required policy is in force and that the premiums have been paid.

14.2 Default

If the Contractor fails to effect or keep in force any of the insurances referred to in the previous Sub-Clause, or fails to provide satisfactory evidence, policies or receipts, the Procuring Agency may, without prejudice to any other right or remedy, effect insurance for the cover relevant to such as a default and pay the premiums due and recover the same plus a sum in percentage given in Contractor Data from any other amounts due to the Contractor.

15. RESOLUTION OF DISPUTES

15.1 Engineer's Decision

If a dispute of any kind whatsoever arises between the Procuring Agency and the Contractor in connection with the works, the matter in dispute shall, in the first place, be referred in writing to the Engineer, with a copy to the other party. Such reference shall state that it is made pursuant to this Clause. No later than the twenty eight (28) days after the day on which he received such reference, the Engineer shall give notice of his decision to the Procuring Agency (Superintending Engineer) and the Contractor.

Unless the Contract has already been repudiated or terminated, the Contractor shall, in every case, continue to proceed with the work with all due diligence, and the Contractor and the Procuring Agency (Superintending Engineer) shall give effect forthwith to every such decision of the Engineer unless and until the same shall be revised, as hereinafter provided in an arbitral award.

15.2 Notice of Dissatisfaction

If a Party is dissatisfied with the decision of the Engineer of consultant or if no decision is given within the time set out in Sub-Clause 15.1 here above, the Party may give notice of dissatisfaction referring to this Sub-Clause within fourteen (14) days of receipt of the decision or the expiry of the time for the decision. If no notice of dissatisfaction is given within the specified time, the decision shall be final and binding on the Parties. If notice of dissatisfaction is given within the specified time, the decision shall be binding on the Parties who shall give effect to it without delay unless and until the decision of the Engineer is revised by an arbitrator.

If a contractor is dissatisfied with the decision of the Engineer of the department or decision is not given in time then he can approach Superintending Engineer within 14 days, in case of dissatisfaction with decision of Superintending Engineer or not decided within 28 days, then arbitration process would be adopted as per clause 15.3.

15.3 Arbitration

A dispute which has been the subject of a notice of dissatisfaction shall be finally settled as per provisions of Arbitration Act 1940 (Act No. X of 1940) and Rules made there under and any statutory modifications thereto. Any hearing shall be held at the place specified in the Contract Data and in the language referred to in Sub-Clause 1.5.

16 INTEGRITY PACT

16.1 If the Contractor or any of his Sub-Contractors, agents or servants is found to have violated or involved in violation of the Integrity Pact signed by the Contractor as Schedule-F to his Bid, then the Procuring Agency shall be entitled to:

- (a) recover from the Contractor an amount equivalent to ten times the sum of any commission, gratification, bribe, finder's fee or kickback given by the Contractor or any of his Sub-Contractors, agents or servants;
- (b) terminate the Contract; and
- (c) recover from the Contractor any loss or damage to the Procuring Agency as a result of such termination or of any other corrupt business practices of the Contractor or any of his Sub-Contractors, agents or servants.

On termination of the Contract under Sub-Para (b) of this Sub-Clause, the Contractor shall demobilize from the site leaving behind Contractor's Equipment which the Procuring Agency instructs, in the termination notice, to be used for the completion of the works at the risk and cost of the Contractor. Payment upon such termination shall be made under Sub-Clause 12.4, in accordance with Sub-Para (c) thereof, after having deducted the amounts due to the Procuring Agency under Sub-Para (a) and (c) of this Sub-Clause.

CONTRACT DATA

(Note: Except where otherwise indicated, all Contract Data should be filled in by the Procuring Agency prior to issuance of the Bidding Documents.)

Sub-Clauses of Conditions of Contract

1.1.3 Procuring Agency's Drawings, if any
(To be listed by the Procuring Agency)

1.1.4 **The Procuring Agency** means

1.1.5 **The Contractor** means

1.1.7 **Commencement Date** means the date of issue of Engineer's Notice to Commence which shall be issued within fourteen (14) days of the signing of the Contract Agreement.

1.1.9 **Time for Completion** _____ days

(The time for completion of the whole of the Works should be assessed by the Procuring Agency)

1.1.20 **Engineer (mention the name along with the designation including whether he belongs to department or consultant) and other details**

1.3 **Documents forming the Contract listed in the order of priority:**

- (a) The Contract Agreement
- (b) Letter of Acceptance
- (c) The completed Form of Bid
- (d) Contract Data
- (e) Conditions of Contract
- (f) The completed Schedules to Bid including Schedule of Prices
- (g) The Drawings, if any
- (h) The Specifications
- (i) _____
- (j) _____

(The Procuring Agency may add, in order of priority, such other documents as form part of the Contract. Delete the document, if not applicable)

2.1 **Provision of Site:** On the Commencement Date

3.1 **Authorized person:**_____

3.2 **Name and address of Engineer's/Procuring Agency's representative**

4.4 **Performance Security:**

Amount_____

Validity_____

(Form: As provided under Standard Forms of these Documents)

5.1 **Requirements for Contractor's design (if any):**

Specification Clause No's_____

7.2 **Program:**

Time for submission: Within fourteen (14) days* of the Commencement Date.

Form of program: _____ *(Bar Chart/CPM/PERT or other)*

7.4 Amount payable due to failure to complete shall be ___% per day up to a maximum of (10%) of sum stated in the Letter of Acceptance

(Usually the liquidated damages are set between 0.05 percent and 0.10 percent per day.)

7.5 **Early Completion**

In case of earlier completion of the Work, the Contractor is entitled to be paid bonus up-to limit and at a rate equivalent to 50% of the relevant limit and rate of liquidated damages stated in the contract data.

9.1 **Period for remedying defects**

10.2 (e) **Variation procedures:**

Day work rates_____

_____ (details)

11.1 Terms of Payments

a) Mobilization Advance

(1) Mobilization Advance up to 10 % of the Contract Price stated in the Letter of Acceptance shall be paid by the Procuring Agency to the Contractor on the works costing Rs.2.5 million or above on following conditions:

- (i) on submission by the Contractor of a Mobilization Advance Guarantee for the full amount of the Advance in the specified form from a Scheduled Bank in Pakistan to the Procuring Agency;
- (ii) Contractor will pay interest on the mobilization advance at the rate of 10% per annum on the advance; and
- (iii) This Advance including the interest shall be recovered in 5 equal installments from the five (05) R.A bills and in case the number of bills is less than five (05) then 1/5th of the advance **inclusive of the interest** thereon shall be recovered from each bill and the balance together with interest be recovered from the final bill. It may be insured that there is sufficient amount in the final bill to enable recovery of the Mobilization Advance.

OR

2) Secured Advance on Materials

(a) The Contractor shall be entitled to receive from the Procuring Agency Secured Advance against an INDENTURE BOND in P W Account Form No. 31(Fin. R. Form No. 2 acceptable to the Procuring Agency of such sum as the Engineer may consider proper in respect of non-perishable materials brought at the Site but not yet incorporated in the Permanent Works provided that:

- (i) The materials are in accordance with the Specifications for the Permanent Works;
- (ii) Such materials have been delivered to the Site and are properly stored and protected against loss or damage or deterioration to the satisfaction and verification of the Engineer but at the risk and cost of the Contractor;
- (iii) The Contractor's records of the requirements, orders, receipts and use of materials are kept in a form approved by the Engineer, and such records shall be available for inspection by the Engineer;
- (iv) The Contractor shall submit with his monthly statement the estimated value of the materials on Site together with such documents as may be required by the Engineer for the purpose of valuation of materials and providing evidence of ownership and payment therefore;

(v) Ownership of such materials shall be deemed to vest in the Procuring Agency and these materials shall not be removed from the Site or otherwise disposed of without written permission of the Procuring Agency;

(vi) The sum payable for such materials on Site shall not exceed 75 % of the (i) landed cost of imported materials, or (ii) ex-factory / ex-warehouse price of locally manufactured or produced materials, or (iii) market price of stands other materials;

(vii) Secured Advance should not be allowed unless &until the previous advance, if an, fully recovered;

(viii) Detailed account of advances must be kept in part II of running account bill; and

(ix) Secured Advance may be permitted only against materials/quantities anticipated to be consumed / utilized on the work within a period of 2 months from the date of issue of secured advance and definitely not for full quantities of materials for the entire work/contract

(b) Recovery of Secured Advance:

(i) Secured Advance paid to the Contractor under the above provisions shall be effected from the monthly payments on actual consumption basis, but not later than period specified in the rules not more than two months (even if unutilized); other conditions.

(ii) As recoveries are made the outstanding accounts of the items concerned in Part II should be reduced b making deduction entries in the column; —deduct quantity utilized in work measured since previous bill,|| equivalent to the quantities of materials used by the contractor on items of work shown as executed in part I of the bill.

(c) Interim payments: The Contractor shall submit to the Engineer monthly statements of the estimated value of the work completed less the cumulative amount certified previously.

(i) The value of work completed comprises the value of the quantities of the items in the Bill of Quantities completed.

(ii) value of secured advance on the materials and valuation of variations (if any).

(iii) Engineer may exclude any item certified in a previous certificate or reduce the proportion of any item previously certified in any certificate in the light of later information.

(v) Retention money and other advances are to be recovered from the bill submitted by contractor.

11.2 *(a) **Valuation of the Works:**

- i) Lump sum price _____(details), or
- ii) Lump sum price with schedules of rates _____ (details),
- or iii) Lump sum price with bill of quantities _____(details),
- or iv) Re-measurement with estimated/bid quantities in the Schedule of Prices or on premium above or below quoted on the rates mentioned in CSR _____(details), or/and
- v) Cost reimbursable _____(details)

11.3 **Percentage of retention*:** *five (5%)*

11.6 **Currency of payment:** Pak. Rupees

14.1 **Insurances:** *(Procuring Agency may decide, keeping in view the nature and the scope of the work)*

Type of cover

The Works

Amount of cover

The sum stated in the Letter of Acceptance plus fifteen percent (15%)

Type of cover

Contractor's Equipment:

Amount of cover

Full replacement cost

Type of cover

Third Party-injury to persons and damage to property

(The minimum amount of third party insurance should be assessed by the Procuring Agency and entered).

Workers:

Other

cover*:

(In each case name of insured is Contractor and Procuring Agency)

14.2 Amount to be recovered

Premium plus _____ percent (____%).

15.3 Arbitration**

Place of Arbitration: _____

** (Procuring Agency to specify as appropriate)*

*** (It has to be in the Province of Sindh)*

STANDARD FORMS

(Note: Standard Forms provided in this document for securities are to be issued by a bank. In case the bidder chooses to issue a bond for accompanying his bid or performance of contract or receipt of advance, the relevant format shall be tailored accordingly without changing the spirit of the Forms of securities).

FORM OF BID SECURITY

(Bank Guarantee)

Guarantee No. _____

Executed on _____

(Letter by the Guarantor to the Procuring Agency)

Name of Guarantor (Scheduled Bank in Pakistan) with address: _____ Name of

Principal (Bidder) with address: _____

Sum of Security (express in words and figures): _____

Bid Reference No. _____ Date of Bid _____

KNOW ALL MEN BY THESE PRESENTS, that in pursuance of the terms of the Bid and at the request of the said Principal, we the Guarantor above-named are held and firmly bound unto the _____, (hereinafter called The —Procuring Agency||) in the sum stated above, for the payment of which sum well and truly to be made, we bind ourselves, our heirs, executors, administrators and successors, jointly and severally, firmly by these presents.

THE CONDITION OF THIS OBLIGATION IS SUCH, that whereas the Principal has submitted the accompanying Bid numbered and dated as above for _____ (Particulars of Bid) to the said Procuring Agency; and

WHEREAS, the Procuring Agency has required as a condition for considering the said Bid that the Principal furnishes a Bid Security in the above said sum to the Procuring Agency, conditioned as under:

- (1) that the Bid Security shall remain valid for a period of twenty eight (28) days beyond the period of validity of the bid;
- (2) that in the event of;
 - (a) the Principal withdraws his Bid during the period of validity of Bid, or
 - (b) the Principal does not accept the correction of his Bid Price, pursuant to Sub-Clause 16.4 (b) of Instructions to Bidders, or
 - (c) failure of the successful bidder to
 - (i) furnish the required Performance Security, in accordance with Sub-Clause IB-21.1 of Instructions to Bidders, or

(ii) sign the proposed Contract Agreement, in accordance with Sub-Clauses IB-20.2 & 20.3 of Instructions to Bidders, the entire sum be paid immediately to the said Procuring Agency for delayed completion and not as penalty for the successful bidder's failure to perform.

NOW THEREFORE, if the successful bidder shall, within the period specified therefore, on the prescribed form presented to him for signature enter into a formal Contract Agreement with the said Procuring Agency in accordance with his Bid as accepted and furnish within fourteen (14) days of receipt of Letter of Acceptance, a Performance Security with good and sufficient surety, as may be required, upon the form prescribed by the said Procuring Agency for the faithful performance and proper fulfilment of the said Contract or in the event of nonwithdrawal of the said Bid within the time specified then this obligation shall be void and of no effect, but otherwise to remain in full force and effect.

PROVIDED THAT the Guarantor shall forthwith pay to the Procuring Agency the said sum stated above upon first written demand of the Procuring Agency without cavil or argument and without requiring the Procuring Agency to prove or to show grounds or reasons for such demand, notice of which shall be sent by the Procuring Agency by registered post duly addressed to the Guarantor at its address given above.

PROVIDED ALSO THAT the Procuring Agency shall be the sole and final judge for deciding whether the Principal has duly performed his obligations to sign the Contract Agreement and to furnish the requisite Performance Security within the time stated above, or has defaulted in fulfilling said requirements and the Guarantor shall pay without objection the sum stated above upon first written demand from the Procuring Agency forthwith and without any reference to the Principal or any other person.

IN WITNESS WHEREOF, the above bounded Guarantor has executed the instrument under its seal on the date indicated above, the name and seal of the Guarantor being hereto affixed and these presents duly signed by its undersigned representative pursuant to authority of its governing body.

Guarantor (Bank)

Witness: 1. Signature _____

1 _____ 2. Name _____

.

3. Title _____

Corporate Secretary (Seal)

2 _____

(Name, Title & Address)

Corporate Guarantor (Seal)

FORM OF PERFORMANCE SECURITY (Bank Guarantee)

Guarantee No. _____

Executed on _____

Expiry Date _____

(Letter by the Guarantor to the Procuring Agency)

Name of Guarantor (Scheduled Bank in Pakistan) with
address: _____Name of Principal (Contractor) with
address: _____Penal Sum of Security (express in words and
figures) _____

Letter of Acceptance No. _____ Dated _____

KNOW ALL MEN BY THESE PRESENTS, that in pursuance of the terms of the Bidding Documents and above said Letter of Acceptance (hereinafter called the Documents) and at the request of the said Principal we, the Guarantor above named, are held and firmly bound unto the _____ (hereinafter called the Procuring Agency) in the penal sum of the amount stated above, for the payment of which sum well and truly to be made to the said Procuring Agency, we bind ourselves, our heirs, executors, administrators and successors, jointly and severally, firmly by these presents.

THE CONDITION OF THIS OBLIGATION IS SUCH, that whereas the Principal has accepted the Procuring Agency's above said Letter of Acceptance for _____ (Name of Contract) for the _____

_____ (Name of Project).

NOW THEREFORE, if the Principal (Contractor) shall well and truly perform and fulfill all the undertakings, covenants, terms and conditions of the said Documents during the original terms of the said Documents and any extensions thereof that may be granted by the Procuring Agency, with or without notice to the Guarantor, which notice is, hereby, waived and shall also well and truly perform and fulfill all the undertakings, covenants terms and conditions of the Contract and of any and all modifications of the said Documents that may hereafter be made, notice of which modifications to the Guarantor being hereby waived, then, this obligation to be void; otherwise to remain in full force and virtue till all requirements of Clause 9, Remedying Defects, of Conditions of Contract are fulfilled.

Our total liability under this Guarantee is limited to the sum stated above and it is a condition of any liability attaching to us under this Guarantee that the claim for payment in writing shall be

received by us within the validity period of this Guarantee, failing which we shall be discharged of our liability, if any, under this Guarantee.

We, _____ (the Guarantor), waiving all objections and defenses under the Contract, do hereby irrevocably and independently guarantee to pay to the Procuring Agency without delay upon the Procuring Agency's first written demand without cavil or arguments and without requiring the Procuring Agency to prove or to show grounds or reasons for such demand any sum or sums up to the amount stated above, against the Procuring Agency's written declaration that the Principal has refused or failed to perform the obligations under the Contract, for which payment will be effected by the Guarantor to Procuring Agency's designated Bank & Account Number.

PROVIDED ALSO THAT the Procuring Agency shall be the sole and final judge for deciding whether the Principal (Contractor) has duly performed his obligations under the Contract or has defaulted in fulfilling said obligations and the Guarantor shall pay without objection any sum or sums up to the amount stated above upon first written demand from the Procuring Agency forthwith and without any reference to the Principal or any other person.

IN WITNESS WHEREOF, the above bounded Guarantor has executed this Instrument under its seal on the date indicated above, the name and corporate seal of the Guarantor being hereto affixed and these presents duly signed by its undersigned representative, pursuant to authority of its governing body.

Guarantor (Bank)

Witness:
1. _____

1. Signature _____
2. Name _____
3. Title _____

Corporate Secretary (Seal)
2. _____

(Name, Title & Address)

Corporate Guarantor (Seal)

FORM OF CONTRACT AGREEMENT

THIS CONTRACT AGREEMENT (hereinafter called the —Agreement||) made on the ____ day of _____ 200 ____ between _____ (hereinafter called the —Procuring Agency||) of the one part and _____ (hereinafter called the —Contractor||) of the other part.

WHEREAS the Procuring Agency is desirous that certain Works, viz _____ should be executed by the Contractor and has accepted a Bid by the Contractor for the execution and completion of such Works and the remedying of any defects therein.

NOW this Agreement witnessed as follows:

1. In this Agreement words and expressions shall have the same meanings as are respectively assigned to them in the Conditions of Contract hereinafter referred to.
2. The following documents after incorporating addenda, if any except those parts relating to Instructions to Bidders, shall be deemed to form and be read and construed as part of this Agreement, viz:
 - (a) The Letter of Acceptance;
 - (b) The completed Form of Bid along with Schedules to Bid;
 - (c) Conditions of Contract & Contract Data;
 - (d) The priced Schedule of Prices/Bill of quantities (BoQ);
 - (e) The Specifications; and
 - (f) The Drawings
3. In consideration of the payments to be made by the Procuring Agency to the Contractor as hereinafter mentioned, the Contractor hereby covenants with the Procuring Agency to execute and complete the Works and remedy defects therein in conformity and in all respects within the provisions of the Contract.
4. The Procuring Agency hereby covenants to pay the Contractor, in consideration of the execution and completion of the Works as per provisions of the Contract, the Contract Price or such other sum as may become payable under the provisions of the Contract at the times and in the manner prescribed by the Contract.

IN WITNESS WHEREOF the parties hereto have caused this Contract Agreement to be executed on the day, month and year first before written in accordance with their respective laws.

Signature of the Contactor

(Seal)

Signature of the Procuring Agency

(Seal)

Signed, Sealed and Delivered in the presence of:

Witness:

(Name, Title and Address)

Witness:

(Name, Title and Address)

MOBILIZATION ADVANCE GUARANTEE

Guarantee No. _____

Executed on _____

(Letter by the Guarantor to the Procuring Agency)

WHEREAS the _____ (hereinafter called the Procuring Agency) has entered into a Contract for

_____ (Particulars of Contract), with

_____ (hereinafter called the Contractor).

AND WHEREAS the Procuring Agency has agreed to advance to the Contractor, at the Contractor's request, an amount of Rs. _____ Rupees _____) which amount shall be advanced to the Contractor as per provisions of the Contract.

AND WHEREAS the Procuring Agency has asked the Contractor to furnish Guarantee to secure the advance payment for the performance of his obligations under the said Contract.

AND WHEREAS _____ (Scheduled Bank) (hereinafter called the Guarantor) at the request of the Contractor and in consideration of the Procuring Agency agreeing to make the above advance to the Contractor, has agreed to furnish the said Guarantee.

NOW THEREFORE the Guarantor hereby guarantees that the Contractor shall use the advance for the purpose of above mentioned Contract and if he fails, and commits default in fulfillment of any of his obligations for which the advance payment is made, the Guarantor shall be liable to the Procuring Agency for payment not exceeding the aforementioned amount.

Notice in writing of any default, of which the Procuring Agency shall be the sole and final judge, as aforesaid, on the part of the Contractor, shall be given by the Procuring Agency to the Guarantor, and on such first written demand payment shall be made by the Guarantor of all sums then due under this Guarantee without any reference to the Contractor and without any objection.

This Guarantee shall come into force as soon as the advance payment has been credited to the account of the Contractor.

This Guarantee shall expire not later than _____ by which date we must have received any claims by registered letter, telegram, telex or telefax.

It is understood that you will return this Guarantee to us on expiry or after settlement of the total amount to be claimed hereunder.

Guarantor (Scheduled Bank)

Witness:

1. _____	1. Signature _____
_____	2. Name _____ Corporate Secretary (Seal)
	3. Title _____
2. _____	
_____	_____
(Name, Title & Address)	Corporate Guarantor (Seal)

INDENTURE FOR SECURED ADVANCES.

(For use in cases in which is contract is for finished work and the contractor has entered into an agreement for the execution of a certain specified quantity of work in a given time).

This INDENTURE made the day of
----- -197--" BETWEEN (hereinafter called "the Contractor" which expression shall where the context so admits or implied be deemed to include his heirs, executors, administrators and assigns) of the one part and THE GOVERNOR OF SINDH (hereinafter called "the Government" of the other part).

WHEREAS by an agreement, dated _____ (hereinafter called the said agreement, the contractor has agreed to perform the under-mentioned works (hereinafter referred to as the said work):-

(Here enter (the description of the works).¹

AND WHEREAS the contractor has applied to the
— for an advance to him of Rupees

(Rs.) on the security of materials absolutely belonging to him and brought by him to the site of the said works the subject of the said agreement for use in the construction of such of the said works as he has undertaken to execute at rates fixed for the finished work (inclusive of the cost of materials and labour and other charge)

AND

WHEREAS the Government has agreed to advance to the Contractor the sum of Rupees, (Rs.) on the security of materials the quantities and other particulars of which are detailed in Part II of Running Account Bill (E). the said works signed by the contractor

Fin R.Form.17.A

on ----- — and on such covenants and conditions as are hereinafter contained and the Government has reserved to itself the option of marking any further advance or advances on the security of other materials brought by the Contractor to the site of the said works.

NOW THIS INDENTURE WTTNESSETH that in pursuance of the said agreement and in consideration of the sum of Rupees ----- - — (Rs. ----- -----) on or before the execution of these presents paid to the Contractor by the Government (the receipt whereof the Contractor doth hereby acknowledge) and of such further advances (if any) as may be made to him as aforesaid (all of which advances are hereinafter collectively referred to as the said amount) the Contractor doth hereby assign unto the Government the said materials by way of security for the said amount

And doth hereby covenant and agree with the Government and declare ay follow :-

(1) That the said sum of Rupees - ----- ----- (Rs. ----- ---) so advanced by the Government to the Contractor as aforesaid and all or any further sum or sums which may be advanced aforesaid shall be employed by the contractor in or towards expending the execution of the said works and for no other purpose whatsoever.

(2) That the materials detailed in the said Running Account Bill (B) which have been

Fin R Form No. 17-A

Offered to and accepted by (he Government as security for the said amount are absolutely by the Contractors own property free from encumbrances of any kind and the Contractor will not make any application for or receive a further advance on the security of materials which are not absolutely his own property and free from encumbrances of any kind and the contractor hereby agrees, at all times, to indemnify and save harmless the Government against all claims whatsoever to any materials in respect of which an advance has been made to him as aforesaid.

(3) That the said materials detailed in the said Running Account Bill (B) and all other

Fin. R. Form No. 17-A

Materials on the security of which any further advance or advances may hereafter be made as aforesaid (hereinafter called the said materials) shall be used by the Contractor solely in *the* execution of the said works in accordance with the directions of the Divisional Officer ----- (hereinafter called the Divisional Officer) and in the terms of the said agreement.

(4) That the Contractor shall make at his own cost all necessary and adequate arrangement for the proper watch, safe custody and protection against all risks of the said material and that

until used in construction as aforesaid the said materials shall remain at the site of the said works in the Contractor's custody and at his own risk and on his own responsibility and shall at all times be open to inspection by (he Divisional Officer or any officer authorized by him. In the event of the said materials of any part (hereof being stolen, destroyed or damaged or becoming deteriorated in a grater degree than is due to reasonable use and wear thereof Contractor will forthwith replace the same with other materials of like qualify or repair and make good the same as required by the Divisional Officer and the materials so brought to replace the said materials so repaired and made good shall also be considered as security for the said amount.

(5) 'Hurt the said materials shall not on any account be removed from the site of the said works except with the written permission of the Divisional Officer or an officer authorized by him in that behalf

(6) That the said amount shall be payable in full when or before the Contractor receives payment, from the Government of the price payable to him for the said works under the terms and provisions of the said agreement PROVIDED THAT if any intermediate payments are made to the contractor on account of work done then on the occasion of each such payment the Government will be at liberty to make a recovery from the Contractors Bill for such payment by deducting there from in the value of the said materials (hen actually used in the construction and in respect of which recovery has not been made previously the value for this purpose being determined in respect of each description of material at (he rates at which the amount of the advances made under these presents were calculated.

(7) That if the Contractor shall at any time make any default in the performance or observation in any respect of any of the terms and provisions of the said agreement or of these presents the total amount of the advance or advances that may still be owing to the Government shall immediately on the happening of such default be repayable by the Contractor to the Government together with interest thereon at twelve percent per annum from the date or respective dates of such advance or advances to the date or repayment and with all costs, charges, damages and expenses incurred by the Government in or for the recovery thereof or the enforcement of this security or otherwise by reason of (he default of the Contractor and any moneys so becoming due and payable shall constitute a debt due from the Contractor to the Government and the Contractor hereby covenants and agrees with the Government to repay and the same respectively to it accordingly.

(8) That the Contractor hereby charges all the said materials with the repayment to the Government of the said sum of Rupees -
(Rs.) and any further sum or sums which may be advanced as aforesaid and all costs charges damages and expenses payable under these present PROVIDED ALWAYS and it is hereby agreed and declared that notwithstanding anything in the said agreement and without prejudice to the powers contained therein if and whether the covenant for payment and repayment hereinbefore contained shall become enforceable and the money owing shall not be paid to accordingly.

Once therewith the Government may at any time thereafter adopt all or any of following courses as it may deem best :-

- (a) Seize and utilize the said materials or any part thereof in the completion of the said works on behalf of the Contractor in accordance with the provisions in that behalf contained in the said agreement debiting the Contractor with the actual cost of effecting such completion the amount due in respect of advances under these presents and crediting the Contractor with the value of work done as he had carried it out in accordance with the said agreement and at the rates thereby provided. If the balance is against the Contractor he is to pay the same to the Government on demand.
- (b) Remove and sell by public auction the seized materials or any part thereof and out of the moneys arising from the sale retain all the sums aforesaid repayable to the Government under these presents and pay over the surplus (if any) to the Contractor.
- (c) Deduct all or any part of the moneys owing out of the security deposit or any sum due to the Contractor under the said agreement.

(9) That except as is expressly provided by the presents interest on the aid advance shall not be payable.

(10) That in the event of any conflict between the provisions of these presents and the said agreement the provisions of these presents shall prevail and in the event of any dispute or difference arising over the construction or effect of these presents the settlement of which has not been hereinbefore expressly provided for the same shall be referred to the Superintending Engineer Circle whose..... decision shall be final and the provisions of the Indian Arbitration Act for the time being in force so far as they are applicable shall apply to any such reference.

In witnesses whereof the* ----- --__..... on behalf of the Governor of Sindh and the said - --have hereunto set their respective hands and seals the day and first above written.

Signed, sealed and delivered by* In the presence of

Seal
1st witness 2nd witness

Signed, sealed and delivered by* In the presence
of Seal

1st Witness 2nd witness

SPECIFICATIONS

[Note for Preparing the Specifications]

A set of precise and clear specifications is a prerequisite for bidders to respond realistically and competitively to the requirements of the user without qualifying their Bids. The specifications must be drafted to permit the widest possible competition and, at the same time, present a clear statement of the required standards of workmanship, materials, performance of the works. Only if this is done objectives of economy, efficiency, and fairness in procurement will be realized and responsiveness of Bids can be ensured, and the subsequent task of bid evaluation can be facilitated. The specifications should require that materials to be incorporated in the works be new, unused, and of the most recent or current models, and incorporated all recent improvements in design and materials unless provided for otherwise in the contract.

Samples of specifications from similar to previous procurements are useful in this respect. The use of metric units is encouraged. Depending on the complexity of the works and the repetitiveness of the type of procurement, it may be advantageous to standardize the Technical Specifications that should cover all classes of workmanship, materials and equipment although not necessarily to be used in a particular procurement.

Care must be taken in drafting specifications to ensure that they are not restrictive. In the specification of standards for equipment, materials, and workmanship, recognized international standards should be used as much as possible. The specifications shall consider all conditions but not limited to seismic conditions, weather conditions and environmental impact. The specifications should state that equipment, materials, and workmanship that meet other authoritative standards, and which ensure at least a substantially equal quality than the standards mentioned, will also be acceptable. The following clause may be inserted in the Specifications.

Sample Clause: Equivalency of Standards and Codes

Wherever reference is made in the Specifications to specific standards and codes to be met by Works to be furnished and tested, the provisions of the latest current edition or revision of the relevant shall apply, unless otherwise expressly stated in the Contract. Other authoritative standards that ensure equivalence to the standards and codes specified will be acceptable.]

** (Note: The Engineer/Procuring Agency may incorporate specific Drawings for Bidding purposes only or may include the detailed drawings in a separate volume, if necessary).*

FORM OF BID AND SCHEDULES TO BID

FORM OF BID

(LETTER OF OFFER / LETTER OF ACCEPTANCE)

Bid Reference No. _____

(Name of Works)

To:

Gentlemen,

1. Having examined the Bidding Documents including Instructions to Bidders, Bidding Data, Conditions of Contract, Contract Data, Specifications, Drawings, if any, Schedule of Prices and Addenda Nos. for the execution of the above-named works, we, the undersigned, being a company doing business under the name of and address _____ and _____ being duly incorporated under the laws of Pakistan hereby offer to execute and complete such works and remedy any defects therein in conformity with the said Documents including Addenda thereto for the Total Bid Price of Rs. _____ (Rupees) _____ or such other sum as may be ascertained in accordance with the said Documents.
2. We understand that all the Schedules attached hereto form part of this Bid.
3. As security for due performance of the undertakings and obligations of this Bid, we submit herewith a Bid Security in the amount of _____ drawn in your favor or made payable to you and valid for a period of twenty eight (28) days beyond the period of validity of Bid.
4. We undertake, if our Bid is accepted, to commence the Works and to deliver and complete the Works comprised in the Contract within the time(s) stated in Contract Data.

- 5. We agree to abide by this Bid for the period of day from the date days from the date fixed for receiving the same and it shall remain binding upon us and may be accepted at any time before the expiration of that period.
- 6. Unless and until a formal Agreement is prepared and executed, this Bid, together with your written acceptance thereof, shall constitute a binding contract between us.
- 7. We undertake, if our Bid is accepted, to execute the Performance Security referred to in Conditions of Contract for the due performance of the Contract.
- 8. We understand that you are not bound to accept the lowest or any bid you may receive.
- 9. We do hereby declare that the Bid is made without any collusion, comparison of figures or arrangement with any other person or persons making a bid for the Works.

Dated this _____ day of _____, 20

Signature _____

in the capacity of _____duly authorized to sign bid for and on behalf of

(Name of Bidder in Block Capitals)

(Seal)

Address:

Witness:

(Signature) _____

Name: _____

Address: _____

SCHEDULES TO BID INCLUDE THE FOLLOWING:

- ☐ Schedule A to Bid: Schedule of Prices
- ☐ Schedule B to Bid: Specific Works Data
- ☐ Schedule C to Bid: Works to be Performed by Subcontractors
- ☐ Schedule D to Bid: Proposed Program of Works
- ☐ Schedule E to Bid: Method of Performing Works
- ☐ Schedule F to Bid: Integrity Pact]

SCHEDULE – A TO BID SCHEDULE OF PRICES:

<u>Sr. No.</u>		<u>Page No.</u>
1.	Preamble to Schedule of Prices.....	24
2.	Schedule of Prices.....	26
	* (a) Summary of Bid Prices	
	* (b) Detailed Schedule of Prices /Bill of Quantities (BOQ)	

** [To be prepared by the Engineer/IBA, Karachi]*

SCHEDULE - A TO BID**PREAMBLE TO SCHEDULE OF PRICES****1. General**

- 1.1 The Schedule of Prices shall be read in conjunction with the Conditions of Contract, Contract Data together with the Specifications and Drawings, if any.
- 1.2 The Contract shall be for the whole of the works as described in these Bidding Documents. Bids must be for the complete scope of works.

2. Description

- 2.1 The general directions and descriptions of works and materials are not necessarily repeated nor summarized in the Schedule of Prices. References to the relevant sections of the Bidding Documents shall be made before entering prices against each item in the Schedule of Prices.

3. Units & Abbreviations

- 3.1 Units of measurement, symbols and abbreviations expressed in the Bidding Documents shall comply with the System International d' Unites (SI Units).

(Note: The abbreviations to be used in the Schedule of Prices to be defined by the IBA, Karachi).

4. Rates and Prices

- 4.1 Except as otherwise expressly provided under the Conditions of Contract, the rates and amounts entered in the Schedule of Prices shall be the rates at which the Contractor shall be paid and shall be the full inclusive value of the works set forth or implied in the Contract; except for the amounts reimbursable, if any to the Contractor under the Contract.

- 4.2 Unless otherwise stipulated in the Contract Data, the premium, rates and prices entered by the bidder shall not be subject to adjustment during the performance of the Contract.
- 4.3 All duties, taxes and other levies payable by the Contractor shall be included in the rates and prices.
- 4.4 The whole cost of complying with the provisions of the Contract shall be included in the items provided in the Schedule of Prices, and where

SCHEDULE - A TO BID

No items are provided, the cost shall be deemed to be distributed among the rates and prices entered for the related items of the Works and no separate payment will be made for those items.

The rates, prices and amounts shall be entered against each item in the Schedule of Prices. Any item against which no rate or price is entered by the bidder will not be paid for by the IBA, Karachi when executed and shall be deemed covered by the rates and prices for other items in the Schedule of Prices.

- 4.5 (a) The bidder shall be deemed to have obtained all information as to and all requirements related thereto which may affect the bid price.
- (b) The Contractor shall be responsible to make complete arrangements for the transportation of the Plant to the Site.

**(IBA, Karachi may modify as appropriate)*

- 4.6 The Contractor shall provide for all parts of the Works to be completed in every respect. Notwithstanding that any details, accessories, etc. required for the complete installation and satisfactory operation of the Works, are not specifically mentioned in the Specifications, such details shall be considered as included in the Contract Price.

5. Bid Prices

5.1 Break-up of Bid Prices

The various elements of Bid Prices shall be quoted as detailed by the IBA, Karachi in the format of Schedule of Prices.

The bidder shall recognize such elements of the costs which he expects to incur the performance of the Works and shall include all such costs in the rates and amounts entered in the Schedule of Prices.

5.2 Total Bid Price

The total of bid prices in the Schedule of Prices shall be entered in the Summary of Bid Prices.

6. Provisional Sums and Day work

- 6.1 Provisional Sums included and so designated in the Schedule of Prices if any, shall be expended in whole or in part at the direction and discretion of the Engineer/IBA, Karachi. The Contractor will only receive payment in respect of Provisional Sums, if he has been instructed by the Engineer/IBA, Karachi to utilize such sums.
- 6.2 Day work rates in the contractor's bid are to be used for small additional amounts of work and only when the Engineer have given written instructions in advance for additional work to be paid for in that way.

SCHEDULE – A TO BID

SCOPE OF WORK
CONSTRUCTION OF MAIN GATE NO. 1 AT IBA MAIN CAMPUS

S.#	Description	Unit	Total QTY.	Rate	Amount
Section : A					
BASED ON COMPOSITE SCHEDULED RATES 2024					
1	DISMENTALING OF DUMMY COLUMNS & BLOCK MASONRY				
	Dismantling cement concrete reinforced separating reinforced cement from concrete cleaning and straightening the same.	CFT	2513.33	229.72	577,362.17
2	EXCAVATION FOR FOUNDATION				
a	Excavtion in foundation of Building Bridges and other structures including dagbelling dressing,refilling around structure with excavated earth Watering and ramming lead upto 5 ft. , lead upto one chain (30 metre) and lift upto 5 ft. (1.5 metre)	CFT	1968.41	11.88	23,384.71
4	BACK FILLING (USING EXCAVATED/SURPLUS EARTH PRESENT AT SITE)				
i)	Filling, watering and ramming earth in under floors with surplus earth from foundation etc. lead upto one chain and lift upto 5 feet.	CFT	948.00	6.50	6,162.00
5	Door with Door Frame				
A	Providing and fixing in position, doors, windows and ventilators of 2"x2"x1/4" angle iron frames and 1-3/4" thick commercial ply wood (3 ply) on both sides, including hold fasts, cleats, iron tower bolts, handles, hinges and one mortice lock.				
i)	Door Frame 7"x2"	SFT	14.00	2995.87	41,942.18
6	MS SECURITY GRILLS				
	Supplying & fixing in position iron/steel grill of 3/4" x 1/4" size flat iron of approved design including painting 3 coats etc. complete (weight not to be less than 3.7 lbs /sft of finished grill) item # 26 , pg 76	Sft	84.00	1,124.10	94,424.40
7	ALUMINUM WINDOWS /VENTILATORS				
l	Supplying & fixing in position Aluminum channels framing for sliding windows & ventilators of made with 5 mm thick tinted glass glazing (Belgium) & Aluminum fly screen l/c handles stoppers & locking arrangementetc. complete Deluxe Model (white) Ref. Item No 84 Page No 83	Sft	84.00	2,386.73	200,485.32

8	PAINT				
(i)	CEILING DESTEMPER				
	Distempering three coats page no 52 item no 24 c	SFT	375.13	17.23	6,463.40
ii)	INTERNAL WALL PAINTING				
	Preparing the surface and painting with matt finish l/c rubbing the surface with Bathy (silicon carbide rubbing brick) filling the voids with zink /chalk / plaster of paris mixture, applying first coat premix, making the surface smooth and then painting 3 coats with matt finish of approved make etc: complete .(new surface) Item No. 36A pg 54	SFT	953.70	49.27	46,988.80
iii)	EXTERNAL WALL PAINTING				
	Preparing the surface and painting with weather coat l/c rubbing the surface with rubbing brick / sand Paper, filling the voids with chalk/ plaster of Paris and then painting with weather coat of approved make. Page No 54 Item no 38A	SFT	953.70	39.38	37,556.71
iv)	PAINT OVER IRON SURFACE				
	Preparing surface and painting guard bars gates, iron bars grating, railings (including standard braces etc) and similar open work. Each Subsequent Coat Item No 5(d-ii) Page No 63	SFT	1728.60	7.12	12,307.63
v)	PAINT OVER WOODEN SURFACE				
	Preparing surface and painting doors and windows any type.(including edges) each subsequent coat of paints Ref. : Item no 5-c i, ii Page 63.	SFT	42.00	18.41	773.22
9	LEAN CONCRETE				
	Cement concrete plain including placing compacting, finishing and curing complete (including screining and washing at stone aggregate without shuttering . 1:4:8 Concrete) Item # 5-I, pg 25				
a)	Under Footing	CFT	380.50	348.83	132,729.82
10	REINFORCED CEMENT CONCRETE				
	Reinforced cement concrete work including all labour and material except the cost of steel reinforcement and its labour for bending and binding which will be paid separately. This rate also includes all kinds of forms moulds lifting shuttering curing rendering and finishing the exposed surface (including screining and washing of shingle)				
	NOTE : ALL STRUCTURAL CONCRETE UPTO PLINTH LEVEL SHALL BE WITH SULPHATE RESISTING CEMENT .				
A)	R.C. work in roof slab, beams columns rafts, lintels and other structural members laid in situ or precast laid in position complete in all respects.				

a)	Ratio 1:2: 4 Conc. 90 lbs OPC cement,2 cft Sand 4 Cft stone aggregate				
(I)	Foundation	cft	520.00	717.59	373,146.80
(II)	Column up to P. Level.	cft	80.00	717.59	57,407.20
(III)	Plinth beams with projected nibs etc	cft	220.00	717.59	157,869.80
(iv)	Columns in super structure	cft	200.00	717.59	143,518.00
(v)	Beams, lintel beams / with projected nibs etc	cft	200.00	717.59	143,518.00
(Vi)	Slabs / projection etc	cft	235.00	717.59	168,633.65
11	STEEL REINFORCEMENT				
a	Fabrication of deformed steel reinforcement for cement concrete including cutting,bending, laying in position, making joints and fastenings including cost of binding wire (also includes removal of rust from bars.) Grade-60, Item # 8-I, pg 26	Cwt	50.00	18934.02	946,701.00
12	BLOCK MASONARY				
a)	SOLID				
i)	6 " OR BELOW THICKNESS				
	Providing and laying 1 :3 : 6 Cement concrete solid Block masorany wall above 6" in thickness set in 1 : 6 cement mortar in G.F ground floor superstructure including raking out joints & curing etc, complete.. (Page No. 27, Item No. 23)	CFT	638.98	493.79	315,521.93
13	RENDERING (PLASTER)				
i)	Internal Plaster				
a)	Cement Plaster 1:4 upto 12' height				
	1/2" thick Plaster (for ceiling and wall)	SFT	953.70	39.83	37,985.87
b)	Cement Plaster 1:6 upto 12' height (Internal)				
	1/2" thick Plaster (for ceiling and wall)	SFT	400.00	37.01	14,804.00
ii)	External Plaster				
a)	Cement Plaster 1:4 upto 12' height				
i)	3/4" thick Plaster (for ceiling and wall)	SFT	953.70	53.82	51,328.13
14	FLOORING				
i)	FLOORING BASE CONC. 1:3 :6				
a)	Cement Concrete plain including placing, compacting, finishing and curing complete including screening and washing at stone aggregate with out shuttering. (Ref. Item No 5 h, Page No16 1:3:6 Conc. Plain	CFT	123.79	388.67	48,113.46
ii)	Glazed Tiles				
C)	Laying floors of approved coloured glazed tiles 1/4" thick floor of approved color & size jointing in white cement and laid over 1:2 cement sand mortar 3/4" thick including grouting with matching color and finishing. Item # 25, pg 46	SFT	471.13	325.40	153,305.70

15	DADO & SKIRTING				
i)	Glazed Tiles				
ii)	Glazed tiles dado 1/4" thick laid in pigment over csm 3/4" thick including finishing Item # 24, pg 45	SFT	106.00	389.36	41,272.16
16	Steel Spiral Stair Case				
	Providing & Erection of 3'-0" dia spiral steel stair case with 4" dia M.s Pipe, 14 guage step plate, Angle iron 1-1/2" x 1" , landing on each floor (03 nos). Including painting with 01 coat of Redoxide and 02 coat of enamel paint complete etc.	RFT	15.00	17,887.50	268,312.50
17	Marble on Compound Wall				
	Laying Verona marble flooring Size 24"x12"x1"/12"x12"x1" fine dressed on the surface without winding set in lime mortar 1:2 including rubbing and polishing of the joints. Item # 28-iii B, pg 46	SFT	475.00	381.88	181,393.00
18	FALSE CEILING				
	Providing & fixing false ceiling of thermopile in panels of required design and size including frame work of Aluminum T-section hanged with nail wire to ceiling etc: completed. Item # 43, pg 43	Sft	850.13	216.75	184,265.68
19	MS RAFTER				
	Providing and installing MS Rafter size 10'-0" x 3' comprising of 2"x1/2" 16SWG MS box 4Nos each welded and supported by 2x1/2" MS 16SWG box 4 Nos at equidistant painting with approved make and shade enamel paint three coats with anticorrosive primer complete as per direction.	Sft	563.30	714.00	402,196.20
20	WINDOW BLIND				
	Supplying & fixing window blinds (Horizontal / vertical) with plain design and of approved colour i/c fixing in windows with necessary accessories. Item # 70, pg 61	Sft	119.00	461.14	54,875.66
21	SEMI SOLID FLUSH DOOR SHUTTER				
	Providing and fixing in position doors, windows and ventilators of first class deodar wood frames, and 1-3/4" thick commercial ply veneer shutters of first class deodar skeleton (Solid Door) and commercial ply wood (3 ply) on both sides including hold fasts, hinges, iron tower bolts, handles and cleats with cord and one Mortice lock and hooks. Item # 9, pg 57				
a)	3'-0"x7'-0"	SFT	21.00	2,998.14	62,960.94
22	Main Gate				

	Supplying and fixing special heavy type steel doors for look - ups with angle iron frame of 2- 1/2" to 2- 1/2" x 3/8" size and shutter of 2" x 2" x 3/8" with 1" diameter M.S bars placed @ 4" center to center with separate locking box having size of 12" x 12" of M. steel sheet embeded in masonry with proper locking arrangement as per approved design including cost of erection of steel gate and fixing in masonry wallin cement concrete 1: 2: 4 etc. complete, Item # 27, pg 76	sft	276.00	4,300.68	1,186,987.68
Total Amount for Schedule items (Section – A)					6,174,697.72
Contractor's Premium/rebate on Schedule item ONLY (%)					
Total Amount with Premium / rebate in Rs. (Section – A)					
SECTION - B: Electrical Wiring and Fixtures		Unit	Qty	Rate	Amount
1	Wiring of light circuit from DB to switch, between switches or first light point / directly controlled from DB with single core PVC insulated 2 x 1C - 4 sq.mm + 1 x 4 sq.mm wires in 25 mm dia PVC conduit complete in all respect.	Nos.	10		
	Wiring from switch to first light point with 2 x 1C - 2.5 sq.mm + 1 x 2.5 sq.mm wires in 25 mm dia PVC conduit complete in all respect Wiring from switch to first light point with 2 x 1C - 2.5 sq.mm + 1 x 2.5 sq.mm wires in 25 mm dia PVC conduit complete in all respect	Nos.	17		
2	Providing, installation, testing & commissioning of LED Down Light Round Ceiling Type - 6500K - min.12watt	Nos.	20		
3	Providing, installation, testing & commissioning of LED Floor bollard light 12 W - 3000K	Nos.	3		
4	Providing, installation, testing & commissioning of Inverter Ceiling Fan 56" - max. 50 Watt	Nos.	5		
5	Providing, installation, testing & commissioning of 1 Ton Split Inverter AC - 12000 BTU	Nos.	2		
6	Providing, installation, testing & commissioning of Smoke Detectors	Nos.	3		
7	Providing, installation, testing & commissioning of Manual Call Point	Nos.	1		
8	Providing, installation, testing & commissioning of Fire Alarm bell / Sounder	Nos.	1		
9	Wiring of complete Fire Alarm System with 2C-1.5 Sq.mm PVC/XLPE (Fire Resistance Cable- 2 hours fire rating) in 25 mm dia PVC Conduit.	Rm	20		
10	RJ-45 including I/O with face plate, back box & accessories complete in all respect.	Nos.	5		

Total Amount for Non - Schedule items (Section – B)	
GROSS TOTAL AMOUNT OF (A+B)	
Add 13% SRB On Gross Total Amount	
Grand Total (A+B) With SST	

Grand Total Amount of A+B in Words:

Rupees: _____

LIST OF DRAWINGS		
SR.NO	TITLE	DRAWING NUMBERS
ARCHITECTURAL DRAWINGS		
1	TITLE PAGE	---
2	LIST OF DRAWINGS	---
3	LEGEND, NOTES & ABBREVIATIONS	A1-1
4	MASTER PLAN	A1-2
5	GATE PLAN-ELEVATION- FRAMING PLAN	A1-3
6	ROOF PLAN & SECTION-3	A1-4
7	FRONT ELEVATION & BACK SID ELEVATION	A1-5
8	GATE PAN & ELEVATION SECTION	A1-6
9	DOOR & WINDOWS ELEVATION SECTION- DETAILS	A1-7
STRUCTURAL DRAWINGS		
10	STRUCTURAL GENERAL NOTE	S1-1
11	REINFORCEMENT ELEVATION SECTION- DETAILS	S1-2
12	FOOTING & PLINTH BEAMS PLAN	S1-3
13	FIRST FLOOR & ROOF PLAN- REINFORCEMENT DETAILS -SECTION	S1-4
14	ELECTRICAL WORKING LEGEND	E1-1
15	GROUND FLOOR CALLING LIGHTING LAYOUT , AC LAYOUT & POWER LAYOUT	E1-2
16	FIRST FLOOR CALLING LIGHTING LAYOUT ,POWER LAYOUT	E1-3
17	FRONT ELEVATION FLOOR LIGHTING LAYOUT	E1-4
18	CC TV CAMERA LAYOUT	E1-5
19	FIR ALARM LAYOUT	E1-6

LEGEND:

ABBREVIATIONS

C/C	CENTER TO CENTER
COL	COLUMN
COMM. PLY	COMMERCIAL PLY
CL	CONCRETE LEVEL
CM	CENTIMETER
CS	CEMENT SAND
D	DOOR
DW	DOOR WINDOW
EQ.	EQUAL
FFL	FINISHED FLOOR LEVEL
FT	FLOOR TRAP
MM	MILLIMETER
M	METER
NSL	NATURAL SURFACE LEVEL
POC	PLAIN CEMENT CONCRETE
PL	PLINTH LEVEL
R	RISER
RCC	REINFORCED CEMENT CONCRETE
C.CON	CONCRETE
RL	ROAD LEVEL
T	TREAD
TH.	THICKNESS, THICK
TYP.	TYPICAL
V	VENTILATOR
W	WINDOW
WB	WASH BASIN
WC	WATER CLOSET
ELE.	ELEVATION

GENERAL NOTES

- ALL DIMENSIONS ARE IN FEET/INCHES UNLESS OTHERWISE MENTIONED.
- WRITTEN DIMENSION SHALL BE GOVERN NO DIMENSION SCALED.
- POTABLE WATER TO BE USED DURING CONSTRUCTION.
- ALL BRICK MASONRY TO BE 9"TH. EXCEPT NOTED OTHERWISE.
- MOCKUPS OF ALL ITEMS TO BE PREPARED FOR ARCHITECT'S APPROVAL.
- ALL FLOORS ARE LAID WITHOUT ANY SLOPE, EXCEPT OF BATH ROOMS, OPEN CORRIDORS AND KITCHEN IN WHICH CASES SLOPE IS TOWARDS DRAIN.
- ALL DOOR OPENINGS TO BE TAKEN AS PLASTERED OPENINGS.
- MS. LOUVERS TO BE RUST TREATED AS PER ARCHITECT'S INSTRUCTION.
- UNTELS TO BE CASTE OVER DOOR/WINDOW OPENING WHERE NEEDED AS PER STRUCTURAL DESIGN.
- 4 12" NB OF BRICK MASONRY @ ALL DOORS LOCATED AT CORNER OF ROOMS EXCEPT NOTED OTHERWISE.
- LEVEL ± IS CONSIDERED AS 1'-0" ABOVE THE EXISTING N.G.L. @ RAMP IN.
- FOR DIMENSIONS OF STRUCTURAL MEMBERS SUCH AS R.C.C. COLUMNS, BEAMS AND SLABS ETC. REFER TO STRUCTURAL DRAWINGS.
- THE DRAWINGS SHALL BE READ IN CONJUNCTION WITH STRUCTURALELECTRICAL & PLUMBING DRAWINGS
- CONTRACTOR SHALL BE RESPONSIBLE FOR THE SAFETY OF THE DIMENSIONS AND LEVELS BEFORE EXECUTION OF WORK. ANY DISCREPANCY, ERROR OR OMISSION IF FOUND SHALL BE BROUGHT TO THE NOTICE OF ENGINEER FOR CORRECTION & APPROVAL
- ALL WORKS PERTAINING TO SERVICES, SUCH AS WATER SUPPLY,SEWERAGE AND DRAINAGE, ELECTRICITY, GAS AND TELEPHONE SHALL BE CARRIED OUT IN ACCORDANCE WITH THE RULES AND REGULATIONS OF CONCERNED AUTHORITIES.
- COLOR SHADES AND QUALITY OF PAINTS, CERAMIC TILES, MARBLE TILES, WATER SUPPLY AND SANITARY FITTINGS ETC.ARE SUBJECT TO THE APPROVAL OF THE ENGINEER.

PROJECT	MAIN GATE KARACHI UNIVERSITY CAMPUS KARACHI			
CITY	KARACHI			
ARCHITECT	IBA-KARACHI			
STRUCTURAL CONSULTANT				
PLUMBING CONSULTANT				
ELECTRICAL CONSULTANT				
MECHANICAL CONSULTANT				
TITLE	ENTRY WALL & GATE LEGEND, NOTES & ABBREVIATIONS			
DATE	ISSUED	DATE	BY	SCALE
				A1.1

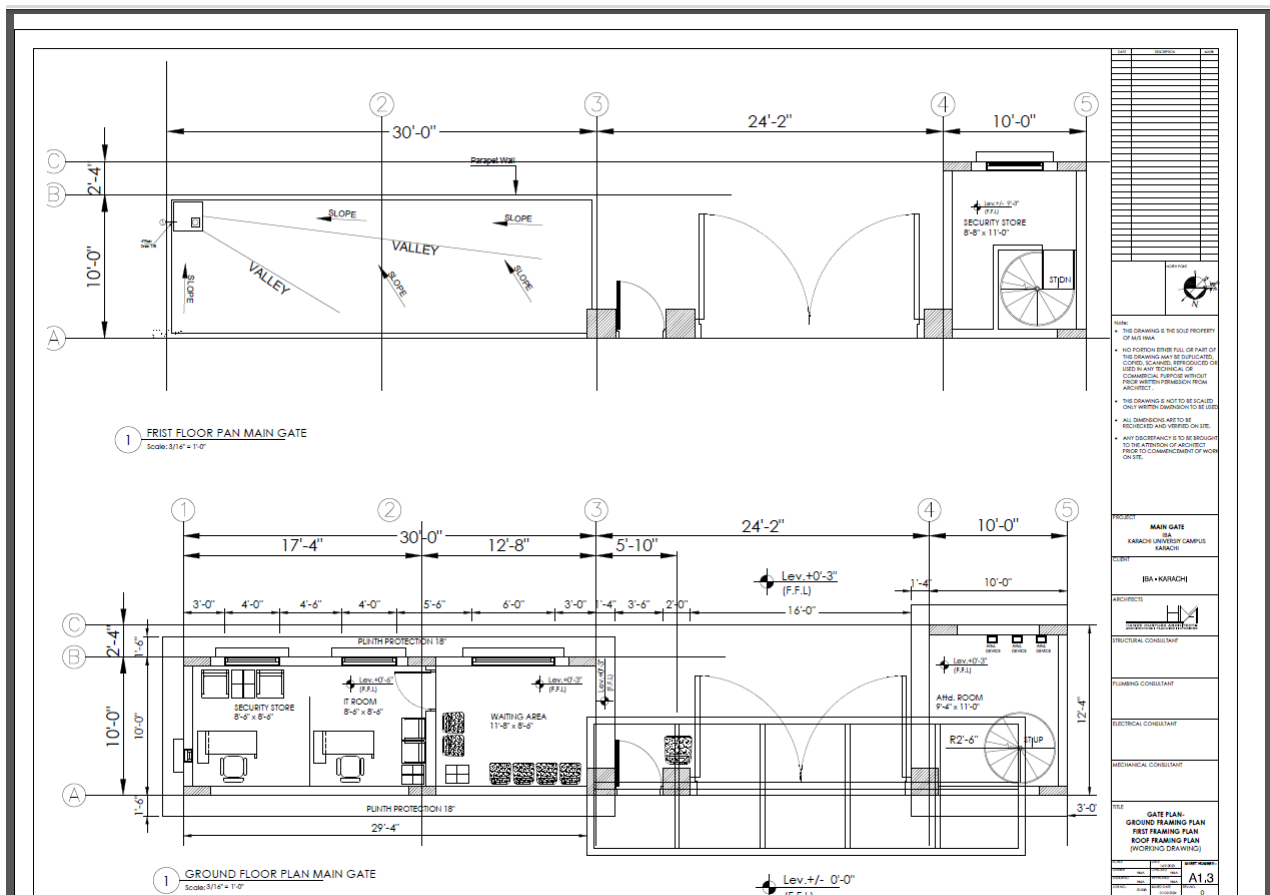
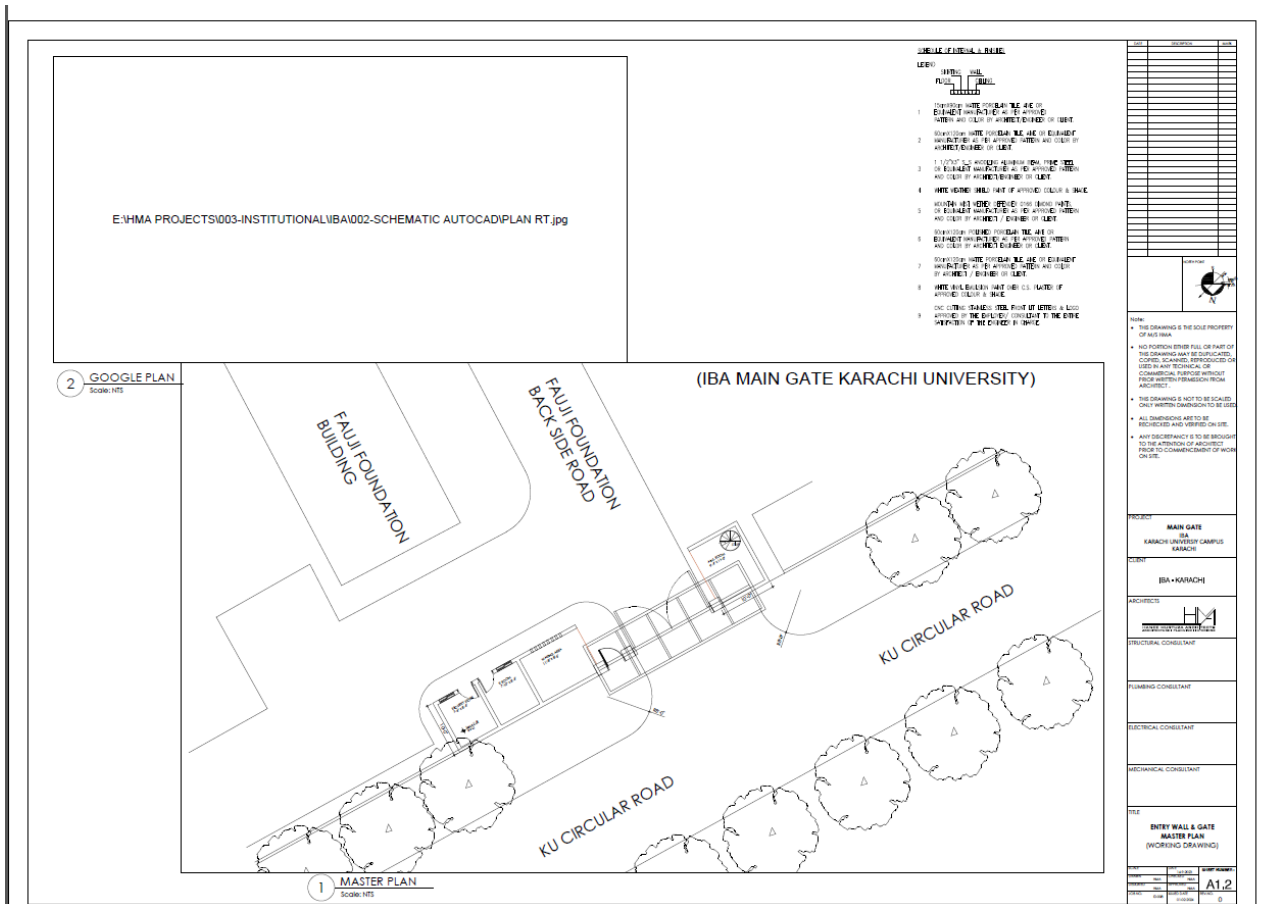

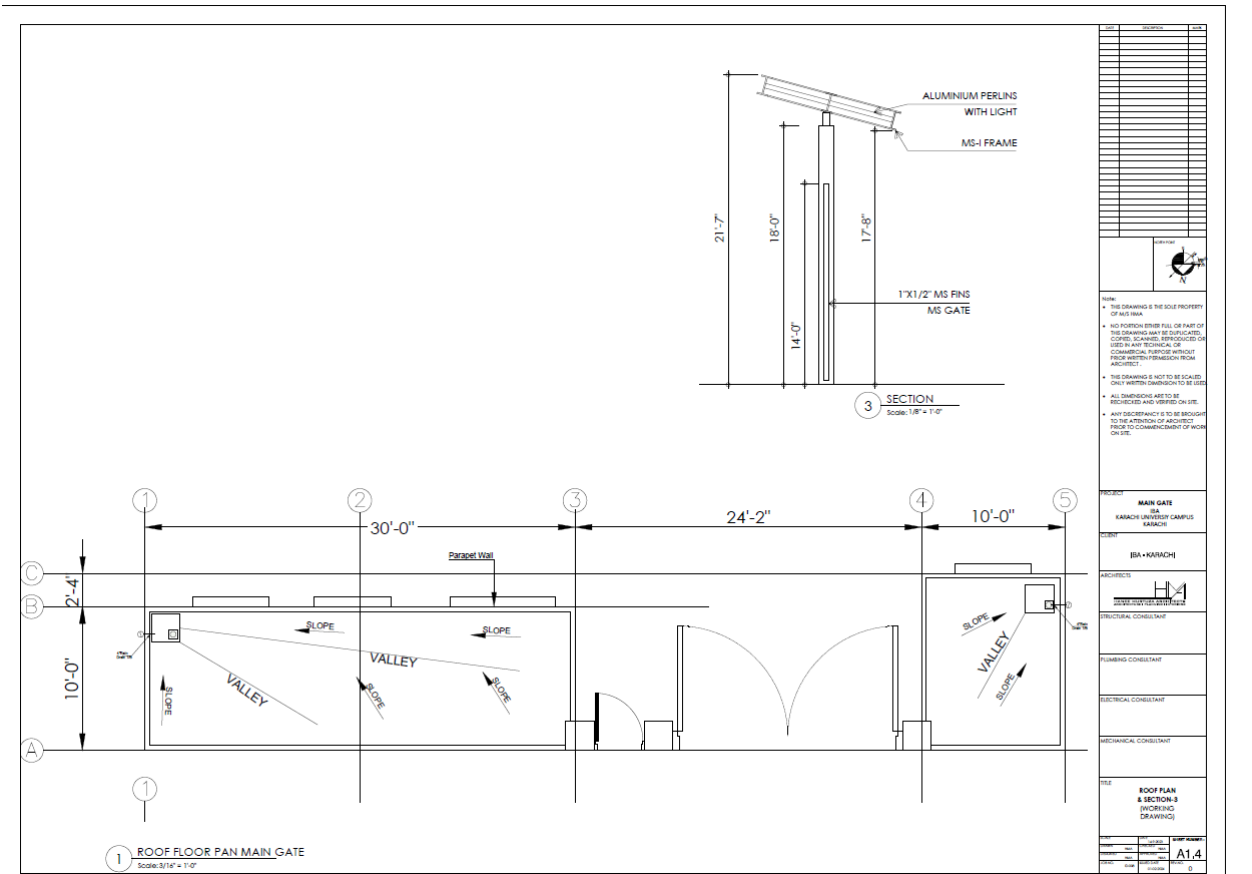

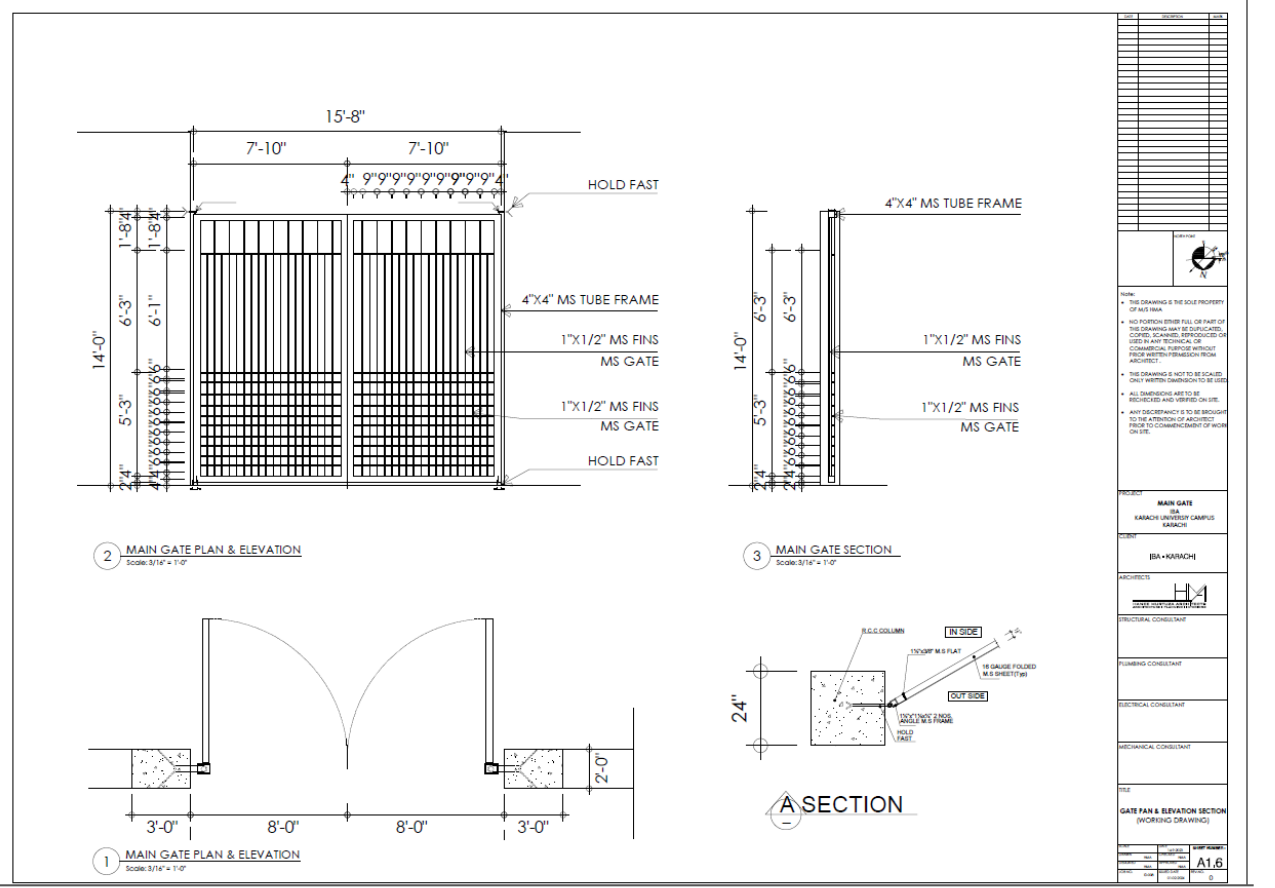
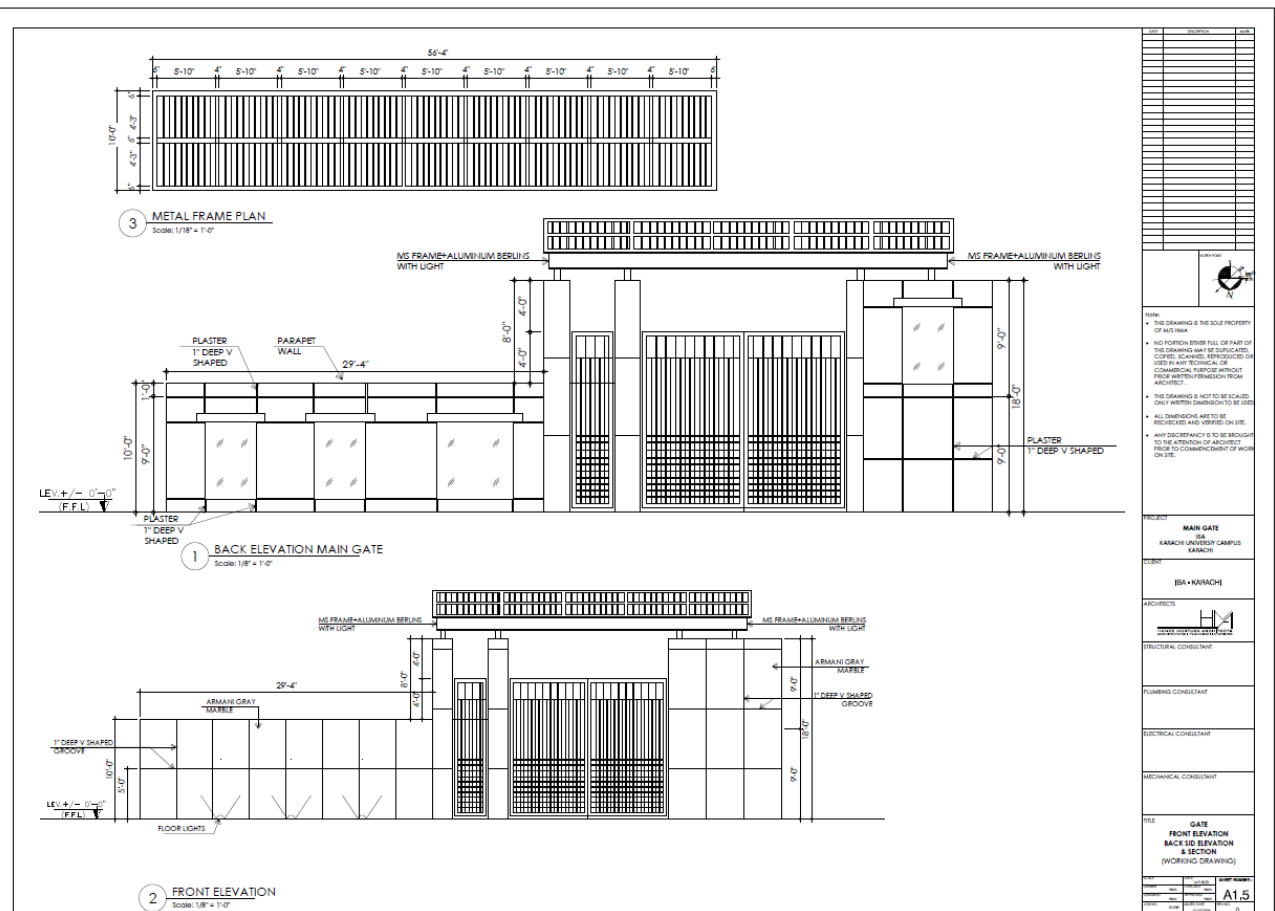

A. GENERAL

- INSTRUCTIONS: THESE INSTRUCTIONS TO BE READ IN CONJUNCTION WITH RELEVANT STRUCTURE DRAWINGS.
- CONSTRUCTION: CO-ORDINATE STRUCTURE DRAWINGS WITH ARCHITECTURAL & OTHER RELEVANT DRAWINGS. IN CASE OF ANY DISCREPANCIES REFER ENGINEER AND ARCHITECT.
- SLAB/JOINT: FOR THE DIMENSION OF THE BUILDING ALWAYS REFER ARCHITECTURAL DRAWING.
- REBAR MASONRY: MET ALL R.C.C. REBAR BEFORE USING FOR MASONRY WORK. USE 14 HORIZONTAL (1/2"-3/4" DIA)RS.
- STORAGE OF MATERIAL: DO NOT STORE SAND OR DEBRIS IN ONE ROOM EXCEEDING DESIGN LIVE LOAD.
- BRAND OF CEMENT: ALWAYS USE FRESH, FINE GRANULATED & FREE OF GRANULES. ALWAYS USE SINGLE BRAND IN ONE POURING.
- ELECTRICAL & PLUMBING WORKS: SEE ELECTRICAL AIR CONDITIONING & SANITARY DRAWING FOR SIZE & LOCATION OF ALL OPENING REQUIRED FOR DUCTS PIPE & FOR ALL PIPES SLEEVES ELECTRICAL CONDUCTS & OTHER ITEMS TO BE EMBEDDED IN CONCRETE OR OTHERWISE INCORPORATED IN STRUCTURAL WORKS.
- SAFETY: THE CONTRACTOR SHALL BE RESPONSIBLE FOR THE SAFETY OF THE BUILDING DURING CONSTRUCTION. ADEQUATE SHORING SHALL BE PROVIDED WHERE REQUIRED. THESE EQUIPMENT BEING TRANSPORTED TO LOCATIONS EXCEEDS THE DESIGN LIVE LOAD PLANNING SHALL BE PROVIDED ON THE FLOOR SLAB & SHORING BENEATH THE FLOOR BEAMS.
- BAR BENDING: IT IS THE RESPONSIBILITY OF THE CONTRACTOR TO PREPARE BENDING SCHEDULES FROM STRUCTURE DRAWING.
- CONSTRUCTION JOINT: CONSTRUCTION JOINT IF REQUIRED SHALL BE PROVIDED IN MIDDLE OF SLAB & BEAM.
- EARTH FILLING: FOR EARTH FILLING USE BHALLOO SOIL OR CONSULT ENGINEER / ARCHITECT. EARTH FILLING SHALL BE DONE IN 15" LAYERS FULLY COMPACTED WITH ELECTRO MECHANICAL COMPACTOR.
- ADDITIONAL FLOOR/ALL FOUNDATION ARE DESIGN FOR GROUND & FIRST FLOOR. NO ADDITIONAL FLOOR SHOULD BE CONSTRUCTED PRIOR TO BOTH ARCHITECTURAL & STRUCTURAL APPROVAL. OTHERWISE STRUCTURAL ENGINEER WILL NOT BE RESPONSIBLE FOR THE SAME.
- CONTRACTOR: CONTRACTOR TO ENSURE SAFETY AND WELL-BEING OF WORKERS AT SITE. CONTRACTOR TO ARRIVE BY LINKS AND STANDARDS FOR PROTECTING PUBLIC HEALTH AND SAFETY OF SURROUNDING AREAS. CONTRACTOR SHALL BE RESPONSIBLE FOR THE SAFETY OF THE STRUCTURE DURING CONSTRUCTION. ADEQUATE MEASURES INCLUDING SHORING SHALL BE PROVIDED IF REQUIRED. CONTRACTOR SHALL TAKE FULL PRECAUTIONS AGAINST ANY FORESEEN DAMAGE OF EXISTING STRUCTURES OR PART THEREOF AND PROVIDE SUITABLE MEASURES INCLUDING SHEET PILING / SHORING TO SATISFY EXISTING STRUCTURE PRIOR TO EXCAVATION AND / OR DEWATERING THE AREA.
- WRITTEN PERMISSION AND POURING SHALL BE DONE WITHOUT PRIOR INSPECTION AND WRITTEN PERMISSION OF ENGINEER INCHARGE.

B. CONCRETE

- WATER CEMENT RATIO: W/C RATIO PER BAG OF CEMENT NOT TO EXCEED 25 LITERS / BAG OF CEMENT. USE ALWAYS DRINKING WATER.
- WASHING AGGREGATE: ALL AGGREGATE TO BE WASHED PROPERLY BEFORE USE.
- FREE FALL OF CONCRETE: FREE FALL OF CONCRETE SHALL NOT BE MORE THAN 6 FEET IN HEIGHT. COLUMN MORE THAN 7 FEET MUST BE POURED THROUGH WINDOW IN SHUTTERING.
- CONCRETE COVER: PROVIDE FOLLOWING CLEAR COVER IF NOT OTHERWISE SPECIFIED:
 - FOUNDATION: 3" TO MAIN REINFORCEMENT.
 - COLUMN: 1" TO MAIN REINFORCEMENT.
 - SLABS: 0.75" TO MAIN REINFORCEMENT.
 - BEAMS BOTTOM: 1.00" TO MAIN REINFORCEMENT.
 - BEAMS SIZES: 0.50" TO MAIN REINFORCEMENT.
- PLINTH/CHART: 1.50" TO MAIN REINFORCEMENT.
- MIXTURE MACHINE: ALL R.C.C. WORK INCLUDING FOOTING & PLINTH BEAMS TO BE CASTE WITH MIXTURE MACHINE MIX TELL UNIFORM COLOR AVOIDED.
- VIBRATOR: ALL R.C.C. WORK TO BE PROPERLY VIBRATED THROUGH ELECTRO-MECHANICAL VIBRATOR. FREQUENCY OF VIBRATOR SHOULD BE 6/W 3000-3000 REV/MIN. THE DURATION OF VIBRATOR SHOULD 5-15 SEC. FORKER SHOULD NOT VIBRATE MORE THAN 3 IN/SEC.
- CONCRETE BLEEDING: WHEN EXCESS WATER ADDED IN CONCRETE ITS BLEED AS IT INITIALLY SET. THIS EXCESS WATER SHOULD BE REMOVED BY SOME ABSORBING MATERIAL SUCH AS CEMENT BED OR SITS ETC.
- CURE STRENGTH: FOR SLAB POURING MAKE THREE CUBES FOR TESTING & SUBMIT ITS RESULT TO THE ENGINEER.
- CONCRETE STRENGTH FOLLOWING MINIMUM CYCLOGICAL STRENGTH REQUIRED FOR R.C.C. STRUCTURE.
 - FOUNDATION: 3500 P.S.I
 - COLUMN: 3500 P.S.I
 - PLINTH BEAM: 2600 P.S.I
 - BEAM/SLAB: 2600 P.S.I
- TROLLEY MOVEMENT: WOODEN PLANKS FOR CONCRETE TROLLEY TO BE PLACED ON STEEL CHAIRS DURING CONCRETE. (PLACE JUTE CLOTH BELOW PLANKS FOR TROLLEY).
- R.C.C. & COLUMN DURING CURING OF COLUMN, ALL R.C.C. AND ALL VERTICAL SURFACES TO BE DONE AFTER WRAPPING WITH JUTE CLOTH FOR AT LEAST 14 DAYS.

- CHUTE SYSTEM: CONCRETING IN ALL VERTICAL MEMBERS TO BE DONE BY CHUTE SYSTEM.
- CURING PERIOD: CURING PERIOD FOR ALL CEMENT CONCRETE WORK TO BE AT LEAST FOR 14 DAYS. FOR SLABS MAKE POOL FOR FIRST 10 DAYS & SPRINKLE WATER FOR THE REST OF 4 DAYS.
- CONCRETE MIX DESIGN: CONCRETE MIX DESIGN TO BE SUBMITTED TO THE ENGINEER FOR APPROVAL PRIOR TO COMMENCEMENT OF WORKS.
- FOOTINGS: EXCEPT FOOTINGS CRUSH SIZE MUST NOT BE GREATER THAN 3" AND NOT LESS THAN 3/8" FOR FOOTING NOT GREATER 3/4" COMPLYING WITH BS882 AND 1201 OR ASTM C33.
- GRADED CONCRETE: ADEQUATE USE FOR REINFORCED CEMENT CONCRETE SHALL CONSIST OF WELL GRADED COARSE AND MAINLY PASSING 4.75MM TEST SIEVE AND COMPLYING WITH BS882 1200 AND 1201 OR ASTM C33.
- REMOVE R.C.C. WORK: UNLESS OTHERWISE NOTED FORM WORK FROM RCC WORK SHALL BE REMOVED ACCORDING TO THE INDICATED BELOW.
 - COLUMN/BEAMS: SIZE = 48 INCH OF POURING: BEAMS BOTTOM -28 DAYS, BEAMS TOP -21 DAYS, CHARTER -28 DAYS
 - SLAB BOTTOM -21 DAYS, CHARTER -28 DAYS
- CONTRACTOR: BEFORE CASTING OF ANY SLAB AND BEAM CONTRACTOR MUST CHECK FOR ANY STARTER BARS REQUIRED FOR PICKED UP COLUMNS ABOVE THE FLOOR OR ANY OTHER INTERCONNECTED MEMBERS.

C. FOUNDATIONS

- BEARING CAPACITY: BEARING CAPACITY OF SOIL IS _____ T/SFT. AS PER SOIL INVESTIGATION REPORT.
- FOUNDATION MESH: FOUNDATION MESH SHOULD BE 3" SHORTEN THEN SIZE OF FOOTING.
- FOUNDATION BASE/ALL FOUNDATION SHOULD BE KEPT ON STRONG NATURAL UNDISTURBED SOIL. ONLY SULPHATE RESISTANT CEMENT SHOULD BE USED IN UNDERGROUND WORK.
- BURGES LEVEL/ALL BURGES TO BE MARKED WITH GRDS & TO BE IN ONE LINE & LEVEL.
- PLINTH LEVEL/PLINTH LEVEL SHOULD BE MARKED ON ALL BURGES.
- FOUNDATION BASE/CASTE OF FOUNDATION CASTE WITHIN THREE DAYS AFTER PLACING 1:4:5.
- LAYER SOLDOTON USE CLAY SOIL FOR BACKFILLING OF FOUNDATION.

D. SHUTTERING

- REDS: TO BE CHECKED BY CONSULTANTS PRIOR TO STEEL PLACEMENT. APPLY OIL ON SHUTTERING BEFORE PLACING.
- SHUTTERING QUALITY: SHUTTERING AND VERTICAL POSTS SHALL BE NEAT, CLEAN & FREE FROM OILS, MUDS & LUBES.
- SHUTTERING LABOUR: LABOUR FOR SHUTTERING PURPOSES.
- POSTS: POSTS SHALL BE TRUE VERTICAL AND SUPPORTED PROPERLY ON FIRM BASES.
- POSTS BRACING: ALL POSTS TO BE BRACED IN BOTH DIRECTIONS AT LEAST AT ONE LEVEL FOR HEIGHT UP TO 6'-0" AND AT TWO LEVELS FOR HEIGHTS GREATER THEN 12'-0".
- TANK SHUTTERING: FOR SWIMMING POOL, U/G.T. & CH.T. DON'T USE METAL STRIP IN CROSS FOR SHUTTERING SUPPORT.
- CHAMES: FOR ROOM SPACING MORE THEN 15 FEET CAMBER THE SHUTTERING 1" FROM MOBLE.
- SHUTTERING STABILITY: STABILITY AND STRENGTH OF SHUTTERING AND CONSTRUCTION WORK IS THE BASIC RESPONSIBILITY OF THE CONTRACTOR. CONSULTANTS SHALL NOT BE RESPONSIBLE FOR ANY QUALITY CONTROL WORK EVEN THOUGH THE CONSULTANT HAS INSPECTED AND CHECKED ANY WORK DONE BY THE CONTRACTOR. FOR SHUTTERING FACTOR OF SAFETY SHOULD NOT BE LESS THEN 4 IE. FOR 100 KG HEIGHT SHUTTERING SHOULD BEAR 400 KG HEIGHT.
- PLATFORM: FOR CONCRETE POURING SEPARATE PLATFORM TO BE MADE AT MAIN SHUTTERING LEVEL.

E. STEEL

- BAR LAP: MINIMUM OVERLAP IN ANY BAR TO BE 64 TIMES THE BAR DIAMETER OR AS GIVEN ON DRAWING IE. FOR #3@24", #4@24", #5@24" & SO ON.
- STEEL STRENGTH: MINIMUM STRENGTH OF MILD STEEL SHALL BE 40,000 PSI AND OF TOP STEEL SHALL BE 60,000 PSI.
- UNDER SIZE USE: UNDER SIZE BARS NOT ALLOWED. CHANGES WHATSOEVER NOT PERMITTED.
- STEEL IDENTIFICATION: MARK "F" INDICATES PLAIN MILD STEEL & MARK "S" INDICATES FOR STEEL.
- CUTTING: CUTTING PLACING OVERLAPPING & LAP LENGTH (TENSION & COMPRESSION SHALL BE AS PER A.C.I. 318-19)
- WELL: PROVIDE "ELL" TO ALL STEEL WHILE CONCRETE DIPS 50% OF BAR.
- BEAMS: STEEL FOR BEAMS DEEPER THAN 30" THE HORIZONTAL REINFORCEMENT OF #3@12" AT EACH FACE SHOULD BE PROVIDED (ALTERNATE)
- BOTTOM BAR: ALL BOTTOM BARS SHOULD BE STRAIGHT UNLESS IT SHOW OTHER SHAPE ON DRAWING.
- CHAIRS: CHAIRS SHOULD ALWAYS BE 1" LESS THEN TOTAL FILLING. ALWAYS MAKE CHAIR WITH #5 STEEL.
- BEAMS TOP LAP: LAP FOR TOP STEEL ONLY BE PROVIDED AT THE CENTRE OF BEAM SUPPORT IF REQUIRED.
- SLABS: BOTTOM LAP LAP FOR BOTTOM STEEL ONLY BE PROVIDED AT THE COLUMN SUPPORT (IF REQUIRED).

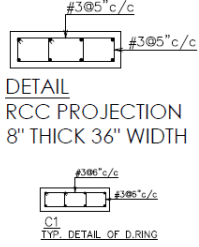
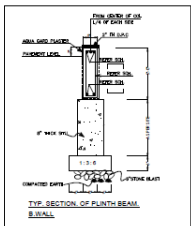
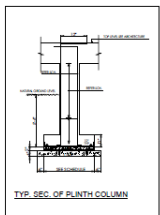
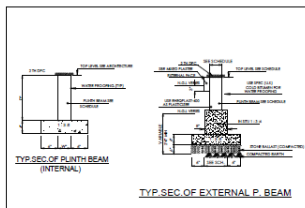
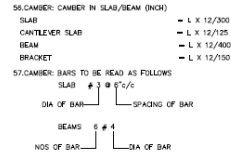

TYPE	F-1	F-2	F-3
AREA	5'-0"X5'-0"	11'-6"X6'-6"	6'-6"X6'-6"
THICKNESS	15"	24"	24"
SHORT BAR	#5@6"/c/c	#5@6"/c/c	#5@6"/c/c
LONG BAR	#5@7"/c/c	#5@7"/c/c	#5@7"/c/c

TYPE	WIDTH	DEPTH	STEEL			
			BOTTOM BAR	TOP BAR	EXTRA BAR	RINGS
RB-1	8"	24"	3#5	3#5	-	#3@6"/8"/c/c
SB-1	8"	24"	3#5	3#5	3#5	#3@6"/8"/c/c
RB-2	8"	24"	3#5	3#5	3#5	#3@6"/8"/c/c

MARK	THICK	BOTTOM BARS		REMARKS
		SHORT BAR	LONG BAR	
RS-1	6"	#3@6"/c/c	#3@7"/c/c	NOTE - 1. ALL TOP STEEL ARE #3@6"/c/c MINIMUM AND THIN IN PLAN 2.TOP DISTRIBUTION BARS #3@6"/c/c
LS-1	6"	#3@6"/c/c	#3@7"/c/c	

	STROY	C1	C2
↑ ROOF FLOOR	8"X24"	24#5	24#5
TO	8#4	A-6-#3@5"/c/c	A-6-#3@5"/c/c
↑ PLINTH	8"X24"	#3@6"/c/c D.RING	B-#3@10"/c/c
TO	8#4	#3@6"/c/c D.RING	A-6-#3@5"/c/c
↑ FOUNDATION			

TYPE	WIDTH	DEPTH	STEEL		
			BOTTOM BAR	TOP BAR	RINGS
PB-1	8"	24"	2#5	2#5	#3@6"/8"/c/c
PB-2	8"	24"	3#5	3#5	#3@6"/8"/c/c
PB-3	12"	24"	3#5	3#5	#3@6"/8"/c/c

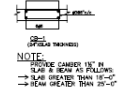

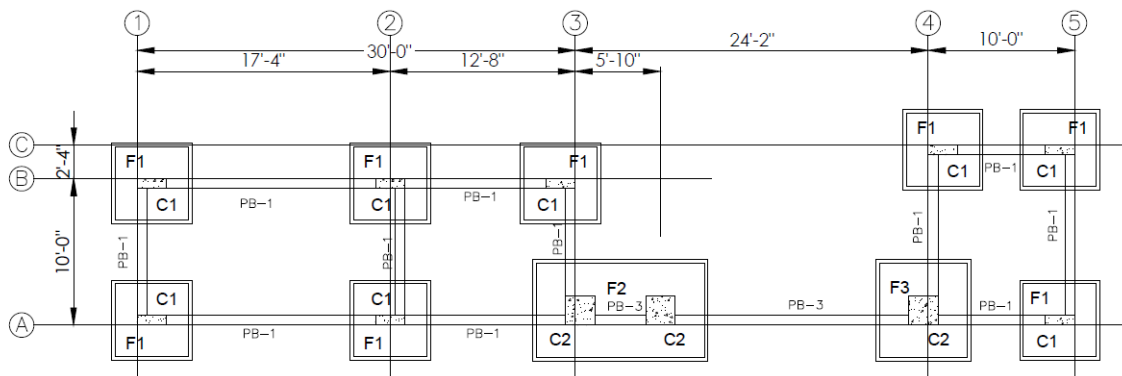

FOOTINGS AND PLINTH PLAN

NOTE:

- 1-ALL FOOTING TO BE CENTERED ON COLUMNS CENTERS UNLESS SHOWN OTHERWISE ON PLAN.
- 2-STEEL MESH SIZE FOR ALL FOOTING TO BE 6" LESS THAN ACTUAL FOOTING SIZE
- 3-MARK # INDICATES TOR STEEL & MARK Ø INDICATES PLAIN MILD STEEL.
- 4-USE #3@6" C/C RINGS IN ALL COLUMNS, IF NOT SHOWN.
- 5-ALL COLUMNS DIMENSIONS ARE IN INCHES.
- 6-f'c (CYLINDRICAL) FOR FOUNDATION & COLUMN AT 28 DAYS 3500PSI
- 7-FOUNDATION DESIGN IS BASED ON SAFE SOIL BEARING CAPACITY OF 1.5 TSF AT 5'-6" DEPTH FROM N.G.L.
- 8-DO NOT SCALE DRAWINGS. FOLLOW WRITTEN DIMENSIONS.
- 9-THIS SCHEDULE TO BE READ IN CONJECTION WITH THE FOUNDATION DWG.
- 10-f'c (CYLINDRICAL) FOR FOUNDATION & COLUMN AT 28 DAYS 3500PSI
- 11-f'c (CYLINDRICAL) FOR BEAMS AT 28 DAYS 3000PSI
- 12-MARK # INDICATES TOR STEEL & MARK Ø INDICATES PLAIN MILD STEEL.

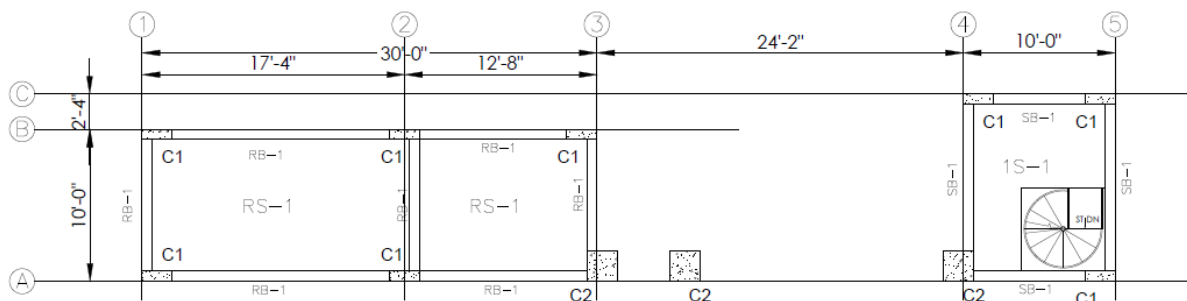





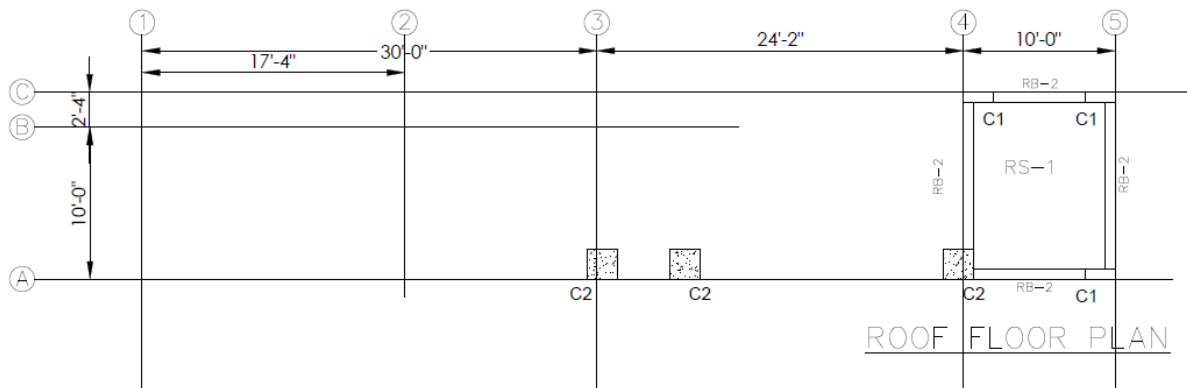

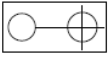

FIRST FLOOR PLAN

FIRST FLOOR PLAN

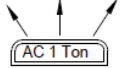

ROOF FLOOR PLAN

LEGEND		
SYMBOL	DESCRIPTION	HEIGHT
	13A INTERNAL SWITCH SOCKET OUTLET COUNTER HEIGHT WATER PROOF	36"Height
	13A INTERNAL SWITCH SOCKET OUTLET	14"Height
	CALLING FAN	
	12/15W LED CEILING LIGHT	
	FLOOR LIGHT	
	SPLIT AIR CONDITIONER	
	20A 3PIN Power Switch Socket Outlet	7'-6" Height
	CC TV CAMERA	16' Height
	GATE LIGHT	10' Height
	FIRE ALARM	9' Height

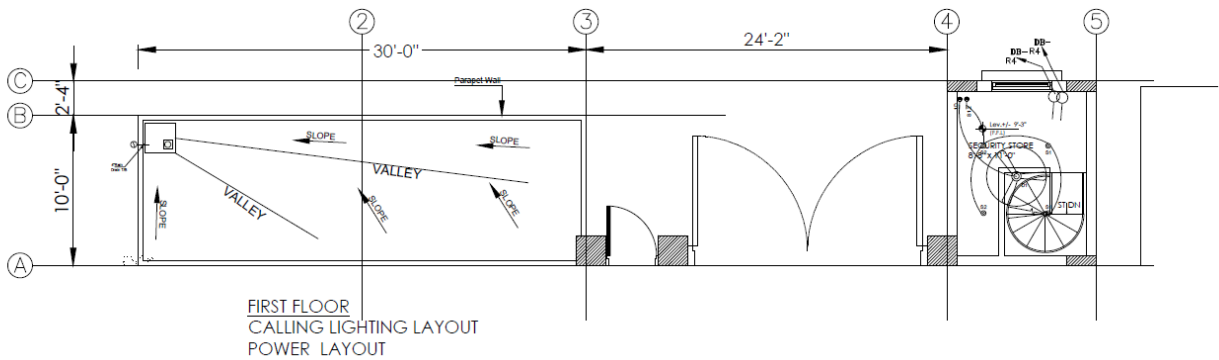
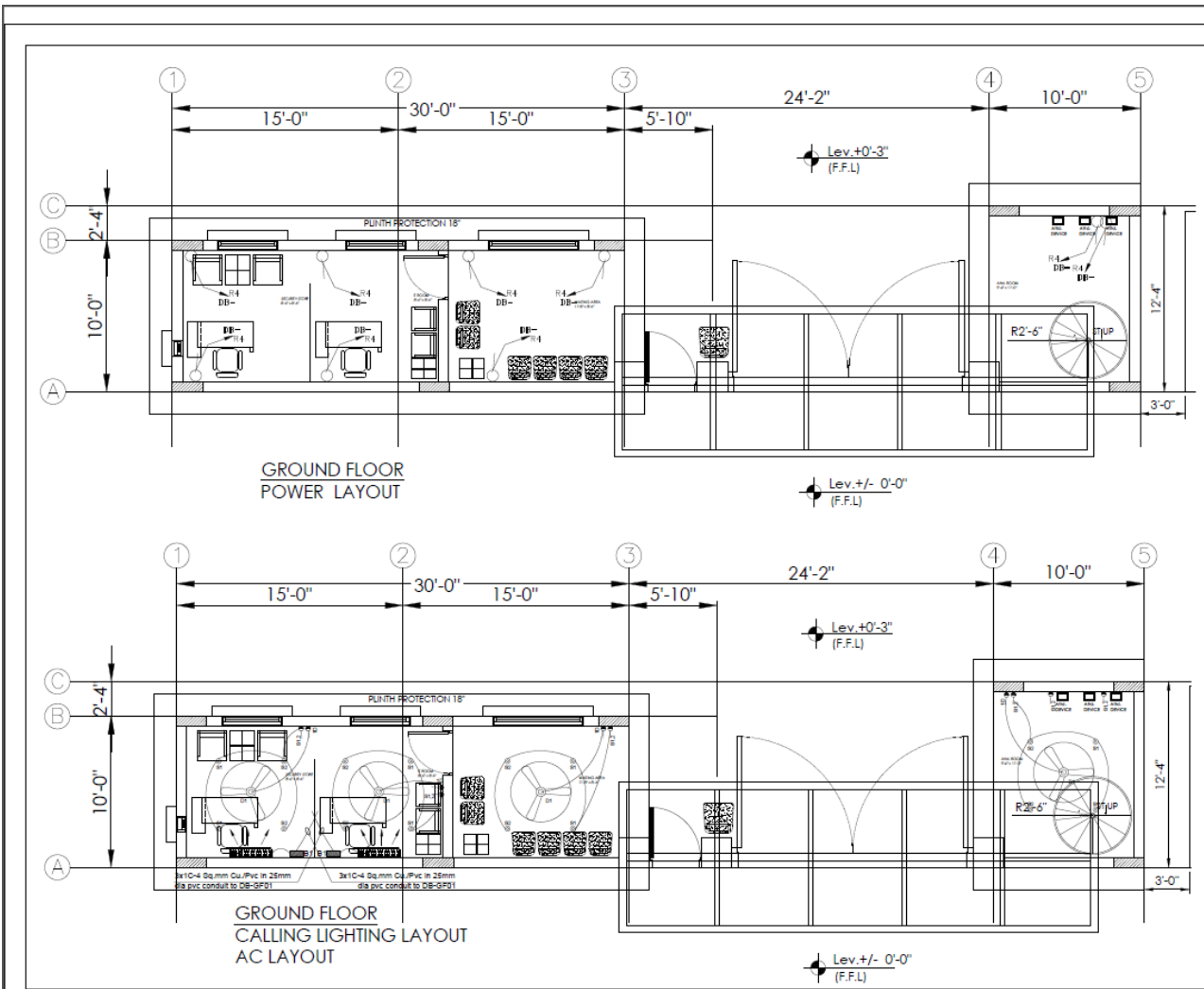

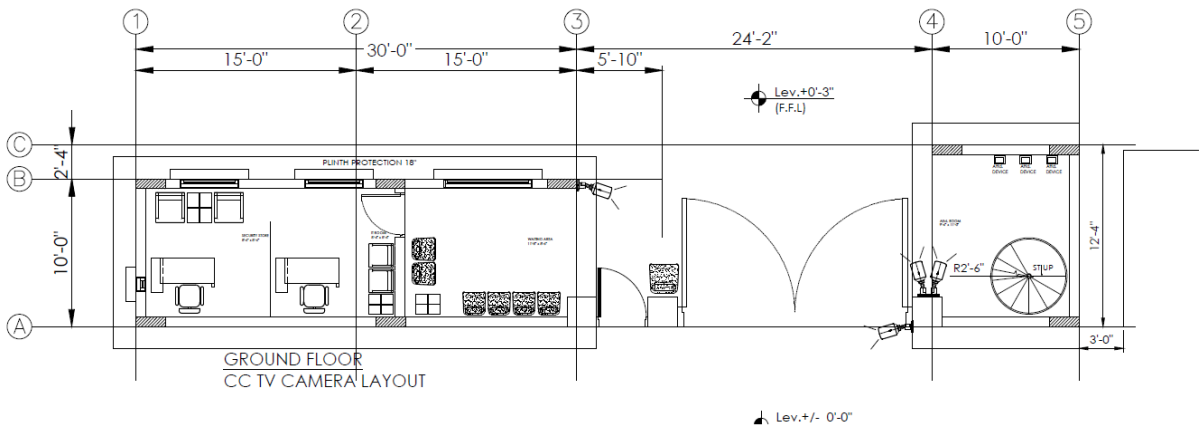
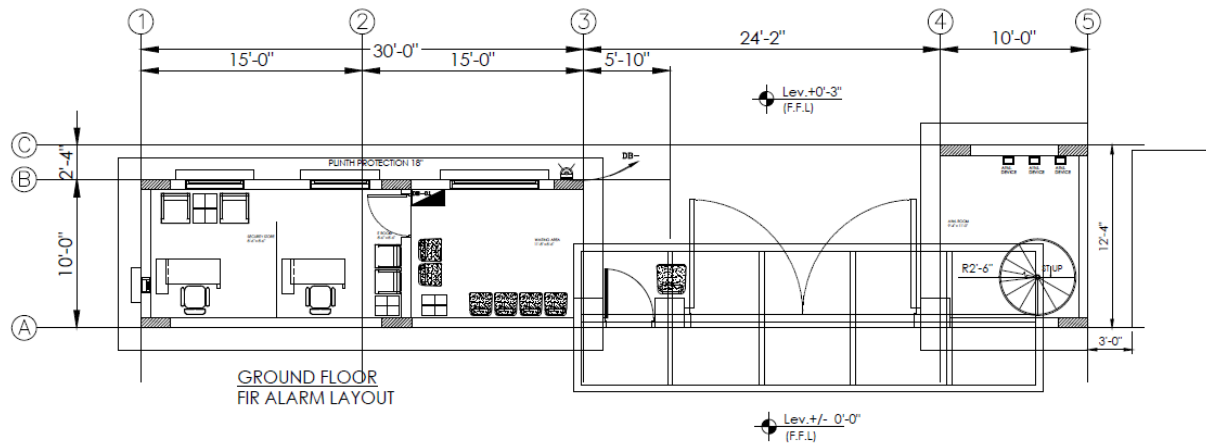
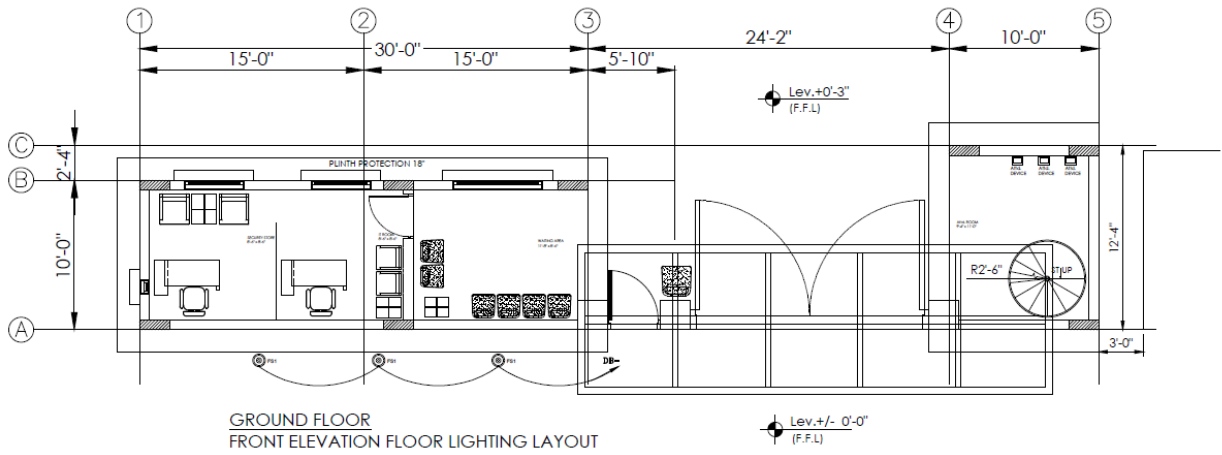

INSTITUTE OF BUSINESS ADMINISTRATION (IBA) KARACHI		
LIST OF APPROVED MANUFACTURERS		
S.NO	DESCRIPTION	APPROVED MANUFACTURERS
a	ELECTRICAL	
1	PVC CONDUIT	DADEX, GALCO, BETA, PRINCE, JEDDAH OR EQUIVALENT
2	DUR DUCT PVC	ADAMJEE, DURA, HUSSAIN & CO. OR EQUIVALENT
3	STEEL CONDUIT	IIL, STEELEX, JAMAL OR EQUIVALENT
4	MS BOXES	POWER TECH,ELECTRECK OR EQUIVALENT
5	LT CABLES & WIRES	PAKISTAN CABLES, FAST, PIONEER, NEWAGE, OR EQUI.
6	SWITCHES, PLUG,DIMMER ETC	CLIPSLE,SCHENIDER,ABB, LEGRAND, BOSCH OR EQUIV.
7	LIGHT FIXTURES	PHLLIPS,SUNLIGHT, OSRAM, BRITILITE OR EQUIVALENT
8	CEILING, EXHAUST FANS	MILLAT, PAK FAN, ROYAL, GFC 55~60 WATTS COPPER
9	MAIN, DISTRIBUTION, BOARD	AREVA, SIEMENS, BABER , LIBRA OR EQUIVALENT
10	MCCBs / MCBs	SCHENIDER,ABB, TERASAKI, LG, GE, MG OR EQUIVALENT
11	CURRENT TRANSFORMER	SIEMENS, COMPLEE,FICO, OR EQUIVALENT
12	SELECTOR SWITCHES	BRETTER,K&N OR EQUIVALENT
13	ENERGY ANALYZER	DUCATI, SOCOMEC OR EQUIVALENT
14	HRC FUSES	SIEMENS,AEG,GE,ABB, HAGER

SCHEDULE – C TO BID**WORKS TO BE PERFORMED BY SUBCONTRACTORS***

The bidder will do the work with his own forces except the work listed below which he intends to sub-contract.

Items of Works to be Sub-Contracted	Name and address of Sub-Contractors	Statement of similar works previously executed. (<i>attach evidence</i>)
--	--	--

Note:

- * *The IBA, Karachi should decide whether to allow subcontracting or not.
In case Procuring Agency decides to allow subcontracting then following conditions shall be complied with:*
1. No change of Sub-Contractors shall be made by the bidder without prior approval of the IBA, Karachi.
 2. The truthfulness and accuracy of the statement as to the experience of Sub-Contractors is guaranteed by the bidder. The IBA, Karachi's judgment shall be final as to the evaluation of the experience of Sub-Contractors submitted by the bidder.
 3. Statement of similar works shall include description, location & value of works, year completed and name & address of the clients.

SCHEDULE – D TO BID**PROPOSED PROGRAMME OF WORKS**

Bidder shall provide a programme in a bar-chart or Program Evaluation and Review Technique (PERT) or Critical Path Method (CPM) showing the sequence of work items by which he proposes to complete the works of the entire Contract. The programme should indicate the sequence of work items and the period of time during which he proposes to complete the works including the activities like designing, schedule of submittal of drawings, ordering and procurement of materials, manufacturing, delivering, construction of civil works, erection, testing and commissioning of works to be supplied under the Contract.

SCHEDULE – E TO BID**METHOD OF PERFORMING WORKS**

The bidder is required to submit a narrative outlining the method of performing the Works. The narrative should indicate in detail and include but not be limited to:

- ▣ The sequence and methods in which he proposes to carry out the Works, including the number of shifts per day and hours per shift, he expects to work.
- ▣ A list of all major items of construction and plant erection, tools and vehicles proposed to be used in delivering/carrying out the works at site.
- ▣ The procedure for installation of equipment and transportation of equipment and materials to the site.
- ▣ Organisation chart indicating head office & field office personnel involved in management, supervision and engineering of the Works to be done under the Contract.

BIDDER QUALIFICATION CRITERIA

S. No	Mandatory Eligibility Criteria (Attach Supporting Document)	Remarks Yes / No
1	Last 3 years (at least) relevant experience	
2	Last 3 years' average annual turnover with minimum 10 million (per year) as bank statement or financial statement.	
3	"Sales tax registration certificate both FBR and / or SRB" and NTN.	
4	PEC Category C-6 or above	

(INTEGRITY PACT)**SCHEDULE – F TO BID****DECLARATION OF FEES, COMMISSION AND BROKERAGE ETC PAYABLE BY CONTRACTORS**

(FOR CONTRACTS WORTH RS. 10.00 MILLION OR MORE)

Contract No. _____

Contract Value: _____

Contract Title: _____

Date [name of Contractor] hereby declares that it has not obtained or induced the procurement of any contract, right, interest, privilege or other obligation or benefit from Government of Sindh (GoS) or any administrative subdivision or agency thereof or any other entity owned or controlled by it (GoS) through any corrupt business practice.

Without limiting the generality of the foregoing, [name of Contractor] represents and warrants that it has fully declared the brokerage, commission, fees etc. paid or payable to anyone and not given or agreed to give and shall not give or agree to give to anyone within or outside Pakistan either directly or indirectly through any natural or juridical person, including its affiliate, agent, associate, broker, consultant, director, promoter, shareholder, sponsor or subsidiary, any commission, gratification, bribe, finder's fee or kickback, whether described as consultation fee or otherwise, with the object of obtaining or inducing the procurement of a contract, right, interest, privilege or other obligation or benefit in whatsoever form from, from IBA, Karachi (PA) except that which has been expressly declared pursuant hereto.

[name of Contractor] accepts full responsibility and strict liability that it has made and will make full disclosure of all agreements and arrangements with all persons in respect of or related to the transaction with PA and has not taken any action or will not take any action to circumvent the above declaration, representation or warranty.

[name of Contractor] accepts full responsibility and strict liability for making any false declaration, not making full disclosure, misrepresenting facts or taking any action likely to defeat the purpose of this declaration, representation and warranty. It agrees that any contract, right, interest, privilege or other obligation or benefit obtained or procured as aforesaid shall, without prejudice to any other rights and remedies available to PA under any law, contract or other instrument, be voidable at the option of PA.

Notwithstanding any rights and remedies exercised by PA in this regard, [name of Supplier/Contractor/Consultant] agrees to indemnify PA for any loss or damage incurred by it on account of its corrupt business practices and further pay compensation to PA in an amount equivalent to ten times the sum of any commission, gratification, bribe, finder's fee or kickback given by [name of Contractor] as aforesaid for the purpose of obtaining or inducing the procurement of any contract, right, interest, privilege or other obligation or benefit in whatsoever form from PA.

.....
[IBA, Karachi]

[Contractor]

CONDITIONS OF CONTRACT

CONTRACT DATA

(Note: Except where otherwise indicated, all Contract Data should be filled in by the IBA, Karachi prior to issuance of the Bidding Documents.)

Sub-Clauses of Conditions of Contract

1.1.3 IBA, Karachi's Drawings, if any
(To be listed by the IBA, Karachi)

1.1.4 **The IBA, Karachi** means

1.1.5 **The Contractor** means

1.1.7 **Commencement Date** means the date of issue of Engineer's Notice to Commence which shall be issued within fourteen (14) days of the signing of the Contract Agreement.

1.1.9 **Time for Completion** _____ days

(The time for completion of the whole of the Works should be assessed by the IBA, Karachi)

1.1.20 **Engineer (mention the name along with the designation including whether he belongs to department or consultant) and other details**

1.3 **Documents forming the Contract listed in the order of priority:**

- (a) The Contract Agreement
- (b) Letter of Acceptance
- (c) The completed Form of Bid
- (d) Contract Data
- (e) Conditions of Contract
- (f) The completed Schedules to Bid including Schedule of Prices
- (g) The Drawings, if any
- (h) The Specifications
- (i) _____
- (j) _____

(The IBA, Karachi may add, in order of priority, such other documents as form part of the

Contract. Delete the document, if not applicable)

2.1 **Provision of Site:** On the Commencement Date

3.1 **Authorized person:** _____

3.2 **Name and address of Engineer's/IBA, Karachi's representative**

4.4 **Performance Security:**

Amount _____

Validity _____

(Form: As provided under Standard Forms of these Documents)

5.1 **Requirements for Contractor's design (if any):**

Specification Clause No's _____

7.2 **Programme:**

Time for submission: Within fourteen (14) days* of the Commencement Date.

Form of programme: _____ *(Bar Chart/CPM/PERT or other)*

7.4 Amount payable due to failure to complete shall be __% per day up to a maximum of (10%) of sum stated in the Letter of Acceptance

(Usually the liquidated damages are set between 0.05 percent and 0.10 percent per day.)

7.5 **Early Completion**

In case of earlier completion of the Work, the Contractor is entitled to be paid bonus up-to limit and at a rate equivalent to 50% of the relevant limit and rate of liquidated damages stated in the contract data.

9.1 **Period for remedying defects**

10.2 **Variation procedures:**

Day work rates (detail)

11.1 Terms of Payments

a) Mobilization Advance

- (1) Mobilization Advance up to 10 % of the Contract Price stated in the Letter of Acceptance shall be paid by the IBA, Karachi to the Contractor on the works costing Rs.2.5 million or above on following conditions:
- (i) on submission by the Contractor of a Mobilization Advance Guarantee for the full amount of the Advance in the specified form from a Scheduled Bank in Pakistan to the IBA, Karachi;
 - (ii) Contractor will pay interest on the mobilization advance at the rate of 10% per annum on the advance; and
 - (iii) This Advance including the interest shall be recovered in 5 equal installments from the five (05) R.A bills and in case the number of bills is less than five (05) then $1/5^{\text{th}}$ of the advance **inclusive of the interest** thereon shall be recovered from each bill and the balance together with interest be recovered from the final bill. It may be insured that there is sufficient amount in the final bill to enable recovery of the Mobilization Advance.

OR

2) Secured Advance on Materials

- (a) The Contractor shall be entitled to receive from the IBA, Karachi Secured Advance against an INDENTURE BOND in P W Account Form No. 31(Fin. R. Form No. 2 acceptable to the Procuring Agency of such sum as the Engineer may consider proper in respect of non-perishable materials brought at the Site but not yet incorporated in the Permanent Works provided that:
- (i) The materials are in accordance with the Specifications for the Permanent Works;
 - (ii) Such materials have been delivered to the Site and are properly stored and protected against loss or damage or deterioration to the satisfaction and verification of the Engineer but at the risk and cost of the Contractor;
 - (iii) The Contractor's records of the requirements, orders, receipts and use of materials are kept in a form approved by the Engineer, and such records shall be available for inspection by the Engineer;
 - (iv) The Contractor shall submit with his monthly statement the estimated value of the materials on Site together with such documents as may be required by the Engineer for the purpose of valuation of materials and providing evidence of ownership and payment therefore;
- (iii) Ownership of such materials shall be deemed to vest in the IBA, Karachi and these materials shall not be removed from the Site or otherwise disposed of without written permission of the IBA, Karachi;

(iv) The sum payable for such materials on Site shall not exceed 75 % of the (i) landed cost of imported materials, or (ii) ex-factory / ex-warehouse price of locally manufactured or produced materials, or (iii) market price of stands other materials;

(v) Secured Advance should not be allowed unless & until the previous advance, if an, fully recovered;

(viii) Detailed account of advances must be kept in part II of running account bill; and

(ix) Secured Advance may be permitted only against materials/quantities anticipated to be consumed / utilized on the work within a period of 2 months from the date of issue of secured advance and definitely not for full quantities of materials for the entire work/contract

(b) Recovery of Secured Advance:

(i) Secured Advance paid to the Contractor under the above provisions shall be effected from the monthly payments on actual consumption basis, but not later than period specified in the rules not more than three months (even if unutilized); other conditions.

(ii) As recoveries are made the outstanding accounts of the items concerned in Part II should be reduced b making deduction entries in the column; -deduct quantity utilized in work measured since previous bill,|| equivalent to the quantities of materials used by the contractor on items of work shown as executed in part I of the bill.

(d) Interim payments: The Contractor shall submit to the Engineer monthly statements of the estimated value of the work completed less the cumulative amount certified previously.

- b
- (i) The value of work completed comprises the value of the quantities of the items in the Bill of Quantities completed.
 - (ii) value of secured advance on the materials and valuation of variations (if any).
 - (iii) Engineer may exclude any item certified in a previous certificate or reduce the proportion of any item previously certified in any certificate in the light of later information.
 - (v) Retention money and other advances are to be recovered from the bill submitted by contractor.

i) Lump sum price _____(details), or

ii) Lump sum price with schedules of rates _____(details), or

iii) Lump sum price with bill of quantities _____(details), or

- iv) Re-measurement with estimated/bid quantities in the Schedule of Prices or on premium above or below quoted on the rates mentioned in CSR _____(details), or/and
- v) Cost reimbursable _____(details)

11.3 **Percentage of retention*:** *five (5%)*

11.6 **Currency of payment:** Pak. Rupees

14.1 **Insurances:** *(IBA, Karachi may decide, keeping in view the nature and the scope of the work)*

Type of cover The Works Amount of cover

The sum stated in the Letter of Acceptance plus fifteen percent (15%)

**Type of cover Contractor 's Equipment: Amount of cover
Full replacement cost**

Type of cover

Third Party-injury to persons and damage to property

(The minimum amount of third party insurance should be assessed by the IBA, Karachi and entered).

Workers:

Other cover*:

(In each case name of insured is Contractor and IBA, Karachi)

14.2 **Amount to be recovered**

Premium plus _____percent (____%).

15.3 **Arbitration****

Place of Arbitration: _____

* *(IBA, Karachi to specify as appropriate)*

** *(It has to be in the Province of Sindh)*

STANDARD FORMS

(Note: Standard Forms provided in this document for securities are to be issued by a bank. In case the bidder chooses to issue a bond for accompanying his bid or performance of contract or receipt of advance, the relevant format shall be tailored accordingly without changing the spirit of the Forms of securities).

FORM OF BID SECURITY
(Bank Guarantee)

(Letter by the Guarantor to the IBA, Karachi)

Guarantee No. Executed on _____

Name of Guarantor (Scheduled Bank in Pakistan) with
address: _____

Name of Principal (Bidder) with
address: _____

Sum of Security (express in words and
figures): _____

Bid Reference No. _____

Date of Bid _____

KNOW ALL MEN BY THESE PRESENTS, that in pursuance of the terms of the Bid and at the request of the said Principal, we the Guarantor above-named are held and firmly bound unto the

, (hereinafter called The -Procuring _____ Agency)) in the sum stated above, for the payment of which sum well and truly to be made, we bind ourselves, our heirs, executors, administrators and successors, jointly and severally, firmly by these presents.

THE CONDITION OF THIS OBLIGATION IS SUCH, that whereas the Principal has submitted the accompanying Bid numbered and dated as above for (Particulars of Bid) to the said Procuring Agency; and Agency; and

WHEREAS, the IBA, Karachi has required as a condition for considering the said Bid that the Principal furnishes a Bid Security in the above said sum to the IBA, Karachi, conditioned as under:

- (1) that the Bid Security shall remain valid for a period of twenty-eight (28) days beyond the period of validity of the bid;
- (2) that in the event of;

- (a) the Principal withdraws his Bid during the period of validity of Bid, or
- (b) the Principal does not accept the correction of his Bid Price, pursuant to Sub-Clause 16.4 (b) of Instructions to Bidders, or
- (c) failure of the successful bidder to
 - (i) furnish the required Performance Security, in accordance with Sub-Clause IB-21.1 of Instructions to Bidders, or
 - (ii) sign the proposed Contract Agreement, in accordance with Sub-Clauses IB-20.2 & 20.3 of Instructions to Bidders,

the entire sum be paid immediately to the said Procuring Agency for delayed completion and not as penalty for the successful bidder's failure to perform.

NOW THEREFORE, if the successful bidder shall, within the period specified therefore, on the prescribed form presented to him for signature enter into a formal Contract Agreement with the said IBA, Karachi in accordance with his Bid as accepted and furnish within fourteen (14) days of receipt of Letter of Acceptance, a Performance Security with good and sufficient surety, as may be required, upon the form prescribed by the said IBA, Karachi for the faithful performance and proper fulfilment of the said Contract or in the event of non- withdrawal of the said Bid within the time specified then this obligation shall be void and of no effect, but otherwise to remain in full force and effect.

PROVIDED THAT the Guarantor shall forthwith pay to the IBA, Karachi the said sum stated above upon first written demand of the IBA, Karachi without cavil or argument and without requiring the IBA, Karachi to prove or to show grounds or reasons for such demand, notice of which shall be sent by the IBA, Karachi by registered post duly addressed to the Guarantor at its address given above.

PROVIDED ALSO THAT the Procuring Agency shall be the sole and final judge for deciding whether the Principal has duly performed his obligations to sign the Contract Agreement and to furnish the requisite Performance Security within the time stated above, or has defaulted in fulfilling said requirements and the Guarantor shall pay without objection the sum stated above upon first written demand from the IBA, Karachi forthwith and without any reference to the Principal or any other person.

IN WITNESS WHEREOF, the above bounded Guarantor has executed the instrument under its seal on the date indicated above, the name and seal of the Guarantor being hereto affixed and these presents duly signed by its undersigned representative pursuant to authority of its governing body.

Guarantor (Bank) 1. -----

Witness:

1. -----

Corporate Secretary (Seal)

2. -----

3. Title

(Name, Title & Address)

Corporate Guarantor (Seal)

**FORM OF PERFORMANCE SECURITY (Bank
Guarantee)**

Guarantee No. _____

Executed on _____

Expiry Date _____

(Letter by the Guarantor to the IBA, Karachi) Name of Guarantor (Scheduled Bank in Pakistan) with
address: _____

Name of Principal (Contractor) with
address: _____

Penal Sum of Security (express in words and
figures) _____

Letter of Acceptance No. _____

Dated

NOW ALL MEN BY THESE PRESENTS, that in pursuance of the terms of the Bidding Documents and above said Letter of Acceptance (hereinafter called the Documents) and at the request of the said Principal we, the Guarantor above named, are held and firmly bound unto

The (hereinafter called the IBA, Karachi)

in the penal sum of the amount stated above, for the payment of which sum well and truly to be made to the said IBA, Karachi, we bind ourselves, our heirs, executors, administrators and successors, jointly and severally, firmly by these presents.

THE CONDITION OF THIS OBLIGATION IS SUCH, that whereas the Principal has accepted the Procuring Agency's above said Letter of Acceptance for _____

_____ (Name of Contract) for the _____

_____ (Name of Project).

NOW THEREFORE, if the Principal (Contractor) shall well and truly perform and fulfill all the undertakings, covenants, terms and conditions of the said Documents during the original terms of the said Documents and any extensions thereof that may be granted by the IBA, Karachi, with or without notice to the Guarantor, which notice is, hereby, waived and shall also well and truly perform and fulfill all the undertakings, covenants terms and conditions of the Contract and of any and all modifications of the said Documents that may hereafter be made, notice of which modifications to the Guarantor being hereby waived, then, this obligation to be void; otherwise to remain in full force and virtue till all requirements of Clause 9, Remedying Defects, of Conditions of Contract are fulfilled.

Our total liability under this Guarantee is limited to the sum stated above and it is a condition of any liability attaching to us under this Guarantee that the claim for payment in writing shall be received by us within the validity period of this Guarantee, failing which we shall be discharged of our liability, if any, under this Guarantee.

We, (the Guarantor), waiving all objections and _____ defenses under the Contract, do hereby irrevocably and independently guarantee to pay to the IBA, Karachi without delay upon the IBA, Karachi's first written demand without cavil or arguments and without requiring the IBA, Karachi to prove or to show grounds or reasons for such demand any sum or sums up to the amount stated above, against the IBA, Karachi's written declaration that the Principal has refused or failed to perform the obligations under the Contract, for which payment will be effected by the Guarantor to IBA, Karachi's designated Bank & Account Number.

PROVIDED ALSO THAT the Procuring Agency shall be the sole and final judge for deciding whether the Principal (Contractor) has duly performed his obligations under the Contract or has defaulted in fulfilling said obligations and the Guarantor shall pay without objection any sum or sums up to the amount stated above upon first written demand from the IBA, Karachi forthwith and without any reference to the Principal or any other person.

IN WITNESS WHEREOF, the above bounded Guarantor has executed this Instrument under its seal on the date indicated above, the name and corporate seal of the Guarantor being hereto affixed and these presents duly signed by its undersigned representative, pursuant to authority of its governing body.

Witness:

1. _____

Guarantor (Bank)

2. _____

Corporate Secretary (Seal)

3. Title _____

(Name, Title & Address)

Corporate Guarantor (Seal)

FORM OF CONTRACT AGREEMENT

THIS CONTRACT AGREEMENT (hereinafter called the -Agreement||) made on the _____ day of 200 between

(hereinafter called the -Procuring Agency||) of the one part and -Contractor||) of the other part.

(hereinafter called the

WHEREAS the IBA, Karachi is desirous that certain Works, viz _____ should be executed by the Contractor and has accepted a Bid by the Contractor for the execution and completion of such Works and the remedying of any defects therein.

NOW this Agreement witnesseth as follows:

1. In this Agreement words and expressions shall have the same meanings as are respectively assigned to them in the Conditions of Contract hereinafter referred to.
2. The following documents after incorporating addenda, if any except those parts relating to Instructions to Bidders, shall be deemed to form and be read and construed as part of this Agreement, viz:
 - (a) The Letter of Acceptance;
 - (b) The completed Form of Bid along with Schedules to Bid;
 - (c) Conditions of Contract & Contract Data;
 - (d) The priced Schedule of Prices/Bill of quantities (BoQ);
 - (e) The Specifications; and
 - (f) The Drawings
3. In consideration of the payments to be made by the Procuring Agency to the Contractor as hereinafter mentioned, the Contractor hereby covenants with the IBA, Karachi to execute and complete the Works and remedy defects therein in conformity and in all respects within the provisions of the Contract.
4. The IBA, Karachi hereby covenants to pay the Contractor, in consideration of the execution and completion of the Works as per provisions of the Contract, the Contract Price or such other sum as may become payable under the provisions of the Contract at the times and in the manner prescribed by the Contract.

IN WITNESS WHEREOF the parties hereto have caused this Contract Agreement to be executed on the day, month and year first before written in accordance with their respective laws.

Signature of the Contactor

Signature of the IBA, Karachi

(Seal)

(Seal)

Signed, Sealed and Delivered in the presence of:

Witness:

Witness:

(Name, Title and Address)

(Name, Title and Address)

MOBILIZATION ADVANCE GUARANTEE

(Letter by the Guarantor to the IBA, Karachi) _____

Guarantee No. _____ Executed on _____

WHEREAS the _____

(hereinafter

called the Procuring Agency) has entered into a Contract for

_____ (Particulars of Contract), with

_____ (hereinafter called the Contractor).

AND WHEREAS the IBA, Karachi has agreed to advance to the Contractor, at the Contractor's request, an amount of Rs. _____ Rupees which amount shall be advanced to the Contractor as per provisions of the Contract.

AND WHEREAS the IBA, Karachi has asked the Contractor to furnish Guarantee to secure the advance payment for the performance of his obligations under the said Contract.

AND WHEREAS

(Scheduled Bank) _____

(hereinafter called the Guarantor) at the request of the Contractor and in consideration of the IBA, Karachi agreeing to make the above advance to the Contractor, has agreed to furnish the said Guarantee.

NOW THEREFORE the Guarantor hereby guarantees that the Contractor shall use the advance for the purpose of above mentioned Contract and if he fails, and commits default in fulfillment of any of his obligations for which the advance payment is made, the Guarantor shall be liable to the Procuring Agency for payment not exceeding the aforementioned amount.

Notice in writing of any default, of which the IBA, Karachi shall be the sole and final judge, as aforesaid, on the part of the Contractor, shall be given by the IBA, Karachi to the Guarantor, and on such first written demand payment shall be made by the Guarantor of all sums then due under this Guarantee without any reference to the Contractor and without any objection.

This Guarantee shall come into force as soon as the advance payment has been credited to

the account of the Contractor.

This Guarantee shall expire not later than _____

by which date we must have received any claims by registered letter, telegram, telex or telefax.

It is understood that you will return this Guarantee to us on expiry or after settlement of the total amount to be claimed hereunder.

Guarantor (Scheduled Bank)

Witness:

1. _____

1. Signature _____

Corporate Secretary (Seal)

2. Name _____

3. Title _____

2. _____

(Name, Title & Address)

Corporate Guarantor (Seal)

INDENTURE FOR SECURED ADVANCES.

(For use in cases in which is contract is for finished work and the contractor has entered into an agreement for the execution of a certain specified quantity of work in a given time).

This INDENTURE made the day of
 -----197--" BETWEEN (hereinafter called "the Contractor" which expression shall where the context so admits or implied be deemed to include his heirs, executors, administrators and assigns) of the one part and THE GOVERNOR OF SINDH (hereinafter called "the Government" of the other part).

WHEREAS by an agreement, dated (hereinafter called the said agreement, the contractor has agreed to perform the under-mentioned works (hereinafter referred to as the said work):-

(Here enter (the description of the works).¹

AND WHEREAS the contractor has applied to the
 — for an advance to him of Rupees (Rs.
) on the security of materials absolutely belonging to him and brought by him to the site of the said works the subject of the said agreement for use in the construction of such of the said works as he has undertaken to execute at rates fixed for the finished work (inclusive of the cost of materials and labour and other charge) AND WHEREAS the Government has agreed to advance to the Contractor the sum of Rupees, (Rs.) on the security of materials the quantities and other particulars of which are detailed in Part II of Running Account Bill (E). the said works signed by the contractor
 Fin R.Form.17.A
 on----- — and on such covenants and conditions as are hereinafter contained and the Government has reserved to itself the option of marking any further advance or advances on the security of other materials brought by the Contractor to the site of the said works.

NOW THIS INDENTURE WTTNESSETH that in pursuance of the said agreement and in consideration of the sum of Rupees..... ----- — (Rs. -----) on or before the execution of these presents paid to the Contractor by the Government (the receipt whereof the Contractor doth hereby acknowledge) and of such further advances (if any) as may be made to him as aforesaid (all of which advances are hereinafter collectively referred to as the said amount) the Contractor doth hereby assign unto the Government the said materials by way of security for the said amount

follow :-

And doth hereby covenant and agree with the Government and declare ay

(1) That the said sum of Rupees- ----- (Rs. -----) so advanced by the Government to the Contractor as aforesaid and all or any further sum or sums which may be advanced aforesaid shall be employed by the

contractor in or towards expending the execution of the said works and for no other purpose whatsoever.

- (2) That the materials detailed in the said Running Account Bill (B) which have been

Fin R Form No. 17-A

Offered to and accepted by (he Government as security for the said amount are absolutely by the Contractors own property free from encumbrances of any kind and the Contractor will not make any application for or receive a further advance on the security of materials which are not absolutely his own property and free from encumbrances of any kind and the contractor hereby agrees, at all times, to indemnify and save harmless the Government against all claims whatsoever to any materials in respect of which an advance has been made to him as aforesaid.

- (3) That the said materials detailed in the said Running Account Bill (B) and all other

Fin. R. Form No. 17-A

Materials on the security of which any further advance or advances may hereafter be made as aforesaid (hereinafter called the said materials) shall be used by the Contractor solely in *the* execution of the said works in accordance with the directions of the Divisional Officer------(hereinafter called the Divisional Officer) and in the terms of the said agreement.

(4) That the Contractor shall make at his own cost all necessary and adequate arrangement for the proper watch, safe custody and protection against all risks of the said material and that until used in construction as aforesaid the said materials shall remain at the site of the said works in the Contractor's custody and at his own risk and on his own responsibility and shall at all times be open to inspection by (he Divisional Officer or any officer authorized by him. In the event of the said materials of any part (hereof being stolen, destroyed or damaged or becoming deteriorated in a grater degree than is due to reasonable use and wear thereof Contractor will forthwith replace the same with other materials of like qualify or repair and make good the same as required by the Divisional Officer and the materials so brought to replace the said materials so repaired and made good shall also be considered as security for the said amount.

(5) 'Hurt the said materials shall not on any account be removed from the site of the said works except with the written permission of the Divisional Officer or an officer authorized by him in that behalf

(6) That the said amount shall be payable in full when or before the Contractor receives payment, from the Government of the price payable to him for the said works under the terms and provisions of the said agreement PROVIDED THAT if any intermediate payments are made to the contractor on account of work done then on the occasion of each such payment the Government will be at liberty to make a recovery from the Contractors Bill for such payment by deducting there from in the value of the said materials (hen actually used in the construction and in respect of which recovery has not been made previously the value for this purpose being determined in respect of each description of material at (he rates at which the amount of the advances made under these presents were calculated.

(7) That if the Contractor shall at any time make any default in the performance or observation in any respect of any of the terms and provisions of the said agreement or of these presents the total amount of the advance or advances that may still be owing to the Government shall immediately on the happening of such default be repayable by the Contractor to the Government together with interest thereon at twelve

percent per annum from the date or respective dates of such advance or advances to the date or repayment and with all costs, charges, damages and expenses incurred by the Government in or for the recovery thereof or the enforcement of this security or otherwise by reason of (he default of the Contractor and any moneys so becoming due and payable shall constitute a debt due from the Contractor to the Government and the Contractor hereby covenants and agrees with the Government to repay and the same respectively to it accordingly.

(8) That the Contractor hereby charges all the said materials with the repayment to the Government of the said sum of Rupees - (Rs.) and any further sum or sums which may be advanced as aforesaid and all costs charges damages and expenses payable under these present PROVIDED ALWAYS and it is hereby agreed and declared that not withstanding anything in the said agreement and without prejudice to the powers contained therein if and whether the covenant for payment and repayment hereinbefore contained shall become enforceable and the money owing shall not be paid to accordingly.

Once therewith the Government may at any time thereafter adopt all or any of following courses as it may deem best ;-

- (a) Seize and utilize the said materials or any part thereof in the completion of the said works on behalf of the Contractor in accordance with the provisions in that behalf contained in the said agreement debiting the Contractor with the actual cost of effecting such completion the amount due in respect of advances under these presents and crediting the Contractor with the value of work done as he had carried it out in accordance with the said agreement and at the rates thereby provided. If the balance is against the Contractor he is to pay the same to the Government on demand.
- (b) Remove and sell by public auction the seized materials or any part thereof and out of the moneys arising from the sale retain all the sums aforesaid repayable to the Government under these presents and pay over the surplus (if any) to the Contractor.
- (c) Deduct all or any part of the moneys owing out of the security deposit or any sum due to the Contractor under the said agreement.

(9) That except as is expressly provided by the presents interest on the aid advance shall not be payable.

(10) That in the event of any conflict between the provisions of these presents and the said agreement the provisions of these presents shall prevail and in the event of any dispute or difference arising over the construction or effect of these presents the settlement of which has not been hereinbefore expressly provided for the same shall be referred to the Superintending Engineer..... Circle whose..... decision shall be final and the provisions of the Indian Arbitration Act for the time being in

force so far as they are applicable shall apply to any such reference.

In witnesses whereof the* ----- __ on behalf of the Governor of Sindh and the said..... — - --have hereunto set their respective hands and seals the day and first above written.

Signed, sealed and delivered by* In the presence of

Seal

1st witness 2nd witness

Signed, sealed and delivered by* In the presence of

Seal

1st Witness 2nd witness

SPECIFICATIONS

[Note for Preparing the Specifications]

A set of precise and clear specifications is a prerequisite for bidders to respond realistically and competitively to the requirements of the user without qualifying their Bids. The specifications must be drafted to permit the widest possible competition and, at the same time, present a clear statement of the required standards of workmanship, materials, performance of the works. Only if this is done objectives of economy, efficiency, and fairness in procurement will be realized and responsiveness of Bids can be ensured, and the subsequent task of bid evaluation can be facilitated. The specifications should require that materials to be incorporated in the works be new, unused, and of the most recent or current models, and incorporated all recent improvements in design and materials unless provided for otherwise in the contract.

Samples of specifications from similar to previous procurements are useful in this respect. The use of metric units is encouraged. Depending on the complexity of the works and the repetitiveness of the type of procurement, it may be advantageous to standardize the Technical Specifications that should cover all classes of workmanship, materials and equipment although not necessarily to be used in a particular procurement.

Care must be taken in drafting specifications to ensure that they are not restrictive. In the specification of standards for equipment, materials, and workmanship, recognized international standards should be used as much as possible. The specifications shall consider all conditions but not limited to seismic conditions, weather conditions and environmental impact. The specifications should state that equipment, materials, and workmanship that meet other authoritative standards, and which ensure at least a substantially equal quality than the standards mentioned, will also be acceptable. The following clause may be inserted in the Specifications.

Sample Clause: Equivalency of Standards and Codes

Wherever reference is made in the Specifications to specific standards and codes to be met by Works to be furnished and tested, the provisions of the latest current edition or revision of the relevant shall apply, unless otherwise expressly stated in the Contract. Other authoritative standards that ensure equivalence to the standards and codes specified will be acceptable.

It is hereby certified that the terms and conditions have been read, agreed upon and signed.

M/s _____

Contact Person: _____

Address _____

Tel # _____ Fax # _____

Mobile # _____ e-mail: _____

NTN # _____ SRB Registration # _____